

E13176
Revised Edition V4
June 2017

English

Mini Desktop PC

User Guide

E410

HDMI™
HIGH-DEFINITION MULTIMEDIA INTERFACE

ASUS®
IN SEARCH OF INCREDIBLE

COPYRIGHT INFORMATION

No part of this manual, including the products and software described in it, may be reproduced, transmitted, transcribed, stored in a retrieval system, or translated into any language in any form or by any means, except documentation kept by the purchaser for backup purposes, without the express written permission of ASUSTeK COMPUTER INC. ("ASUS").

ASUS PROVIDES THIS MANUAL "AS IS" WITHOUT WARRANTY OF ANY KIND, EITHER EXPRESS OR IMPLIED, INCLUDING BUT NOT LIMITED TO THE IMPLIED WARRANTIES OR CONDITIONS OF MERCHANTABILITY OR FITNESS FOR A PARTICULAR PURPOSE. IN NO EVENT SHALL ASUS, ITS DIRECTORS, OFFICERS, EMPLOYEES OR AGENTS BE LIABLE FOR ANY INDIRECT, SPECIAL, INCIDENTAL, OR CONSEQUENTIAL DAMAGES (INCLUDING DAMAGES FOR LOSS OF PROFITS, LOSS OF BUSINESS, LOSS OF USE OR DATA, INTERRUPTION OF BUSINESS AND THE LIKE), EVEN IF ASUS HAS BEEN ADVISED OF THE POSSIBILITY OF SUCH DAMAGES ARISING FROM ANY DEFECT OR ERROR IN THIS MANUAL OR PRODUCT.

Products and corporate names appearing in this manual may or may not be registered trademarks or copyrights of their respective companies, and are used only for identification or explanation and to the owners' benefit, without intent to infringe.

SPECIFICATIONS AND INFORMATION CONTAINED IN THIS MANUAL ARE FURNISHED FOR INFORMATIONAL USE ONLY, AND ARE SUBJECT TO CHANGE AT ANY TIME WITHOUT NOTICE, AND SHOULD NOT BE CONSTRUED AS A COMMITMENT BY ASUS. ASUS ASSUMES NO RESPONSIBILITY OR LIABILITY FOR ANY ERRORS OR INACCURACIES THAT MAY APPEAR IN THIS MANUAL, INCLUDING THE PRODUCTS AND SOFTWARE DESCRIBED IN IT.

Copyright © 2017 ASUSTeK COMPUTER INC. All Rights Reserved.

LIMITATION OF LIABILITY

Circumstances may arise where because of a default on ASUS' part or other liability, you are entitled to recover damages from ASUS. In each such instance, regardless of the basis on which you are entitled to claim damages from ASUS, ASUS is liable for no more than damages for bodily injury (including death) and damage to real property and tangible personal property; or any other actual and direct damages resulted from omission or failure of performing legal duties under this Warranty Statement, up to the listed contract price of each product.

ASUS will only be responsible for or indemnify you for loss, damages or claims based in contract, tort or infringement under this Warranty Statement.

This limit also applies to ASUS' suppliers and its reseller. It is the maximum for which ASUS, its suppliers, and your reseller are collectively responsible.

UNDER NO CIRCUMSTANCES IS ASUS LIABLE FOR ANY OF THE FOLLOWING: (1) THIRD-PARTY CLAIMS AGAINST YOU FOR DAMAGES; (2) LOSS OF, OR DAMAGE TO, YOUR RECORDS OR DATA; OR (3) SPECIAL, INCIDENTAL, OR INDIRECT DAMAGES OR FOR ANY ECONOMIC CONSEQUENTIAL DAMAGES (INCLUDING LOST PROFITS OR SAVINGS), EVEN IF ASUS, ITS SUPPLIERS OR YOUR RESELLER IS INFORMED OF THEIR POSSIBILITY.

SERVICE AND SUPPORT

Visit our multi-language web site at <https://www.asus.com/support>

Contents

About this manual	6
Conventions used in this manual	7
Safety information	8
Setting up your system.....	8
Care during use	8
Package contents	10

Chapter 1: Hardware Setup

Getting to know your PC	11
Front view.....	11
Rear view	13

Chapter 2: Using your PC

Positioning your PC	15
Mounting your PC on the stand.....	15
Installing your PC to a monitor.....	16
Using your PC	20
Connecting to an external display	20
Connecting to a USB device	20
Connecting the wireless antenna (optional).....	21
Turning on your PC	22
Configuring the audio output via an HDMI device	23
Keyboard shortcuts	25

Chapter 3: Working with Windows® 7

Starting for the first time	27
Using the Start menu	28
Using the taskbar.....	29
Using the notification area.....	30
Using Windows® Explorer.....	31
Backing up files	33
Restoring your system settings	33
Using Windows® 7 Action Center	34
Using Windows® Update	34
Setting up a user account and password	35
Using Windows® Help and Support	35

Contents

Chapter 4: Working with Windows® 8.1

System requirements.....	37
Starting for the first time	38
Windows® 8.1 lock screen	38
Windows® UI	39
Start Screen.....	39
Windows® apps.....	39
Start button	42
Customizing your Start screen.....	44
Working with Windows® apps	45
Launching apps.....	45
Customizing apps from the Start screen.....	45
Accessing the Apps screen.....	46
Charms bar.....	48
Snap feature	50
Other keyboard shortcuts.....	51
Turning your PC off.....	53
Putting your PC to sleep	53
Entering the BIOS Setup	54
Quickly enter the BIOS.....	55

Chapter 5: Working with Windows® 10

Starting for the first time	57
Using the Windows® 10 UI	58
Start menu.....	59
Pinning apps to the Start screen or taskbar.....	59
Start screen.....	60
Moving apps on the Start screen.....	60
Unpinning apps from the Start screen	60
Taskbar.....	61
Unpinning apps from the taskbar	61
Using the Task View	61

Contents

Snap feature	62
Using Snap	62
Using your mouse	62
Using your keyboard	62

Chapter 6: Connecting to the Internet

Connecting on Windows® 7	63
Wireless connection	63
Wired connection	64
Connecting on Windows® 8.1	67
Wi-Fi connection	67
Wired connection	68
Connecting on Windows® 10	70
Wi-Fi connection	70
Wired connection	71

Chapter 7: Recovering your system

Recovery options on Windows® 7	75
Using the Recovery Partition	75
Recovery options on Windows® 8.1	78
Removing everything and reinstalling Windows	78
Recovery options on Windows® 10	79
Removing everything and reinstalling Windows®	79

Appendices

Regulatory notices	81
ASUS contact information	86

About this manual

This manual provides information about the hardware and software features of your PC, organized through the following chapters:

Chapter 1: Hardware Setup

This chapter details the hardware components of your PC.

Chapter 2: Using your PC

This chapter provides you with information on using your PC.

Chapter 3: Working with Windows® 7

This chapter provides an overview of using Windows® 7 in your PC.

Chapter 4: Working with Windows® 8.1

This chapter provides an overview of using Windows® 8.1 in your PC.

Chapter 5: Working with Windows® 10

This chapter provides an overview of using Windows® 10 in your PC.

Chapter 6: Connecting to the Internet

This chapter provides information on connecting your PC to a wired or Wi-Fi network.

Chapter 7: Recovering your system

This chapter provides recovery options for your PC.

Appendices

This section includes notices and safety statements for your PC.

NOTE: For **Windows® 8.1 OS**, the user manual is located in the following folder in your PC: C:\Program Files(X86)\ASUS\eManual

Conventions used in this manual

To highlight key information in this manual, some text are presented as follows:

IMPORTANT! This message contains vital information that must be followed to complete a task.

NOTE: This message contains additional information and tips that can help complete tasks.

WARNING! This message contains important information that must be followed to keep you safe while performing certain tasks and prevent damage to your PC's data and components.

Typography

Bold text

Indicates a menu or an item to select.

Italic

This indicates sections that you can refer to in this manual.

Safety information

Your EeeBox PC is designed and tested to meet the latest standards of safety for information technology equipment. However, to ensure your safety, it is important that you read the following safety instructions.

Setting up your system

- Read and follow all instructions in the documentation before you operate your system.
- Do not use this product near water or a heated source such as a radiator.
- Set up the system on a stable surface with the provided stand. Never use the system alone without the stand.
- Openings on the chassis are for ventilation. Do not block or cover these openings. Make sure you leave plenty of space around the system for ventilation. Never insert objects of any kind into the ventilation openings.
- Use this product in environments with ambient temperatures between 0°C and 35°C.
- If you use an extension cord, make sure that the total ampere rating of the devices plugged into the extension cord does not exceed its ampere rating.
- This equipment should be installed and operated with a minimum distance of 20cm between the radiator and your body.

Care during use

- Do not walk on the power cord or allow anything to rest on it.
- Do not spill water or any other liquids on your system.
- When the system is turned off, a small amount of electrical current still flows. Always unplug all power, modem, and network cables from the power outlets before cleaning the system.

- If you encounter the following technical problems with the product, unplug the power cord and contact a qualified service technician or your retailer.
 - The power cord or plug is damaged.
 - Liquid has been spilled into the system.
 - The system does not function properly even if you follow the operating instructions.
 - The system was dropped or the cabinet is damaged.
 - The system performance changes.

Lithium-Ion Battery Warning

CAUTION: Danger of explosion if battery is incorrectly replaced. Replace only with the same or equivalent type recommended by the manufacturer. Dispose of used batteries according to the manufacturer's instructions.







NO DISASSEMBLY

The warranty does not apply to the products that have been disassembled by users

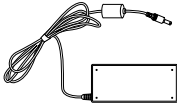

DO NOT throw the PC in municipal waste. This product has been designed to enable proper reuse of parts and recycling. This symbol of the crossed out wheeled bin indicates that the product (electrical, electronic equipment, and mercury-containing button cell battery) should not be placed in municipal waste. Check local technical support services for product recycling.

Package contents

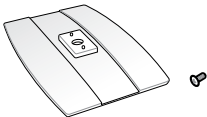
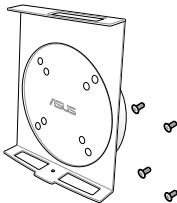
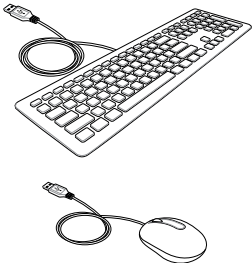
		
E410	AC adapter	Power cord
		
Antenna (optional)	Warranty card	Quick Installation Guide (QIG)
		
Stand (optional)	VESA mount and screw pack (optional)	Keyboard / Mouse (optional)

NOTES:

- Actual product specifications may vary with territories.
- If the device or its components fail or malfunction during normal and proper use within the warranty period, bring the warranty card to the ASUS Service Center for replacement of the defective components.

Chapter 1: Hardware Setup

Getting to know your PC

Front view

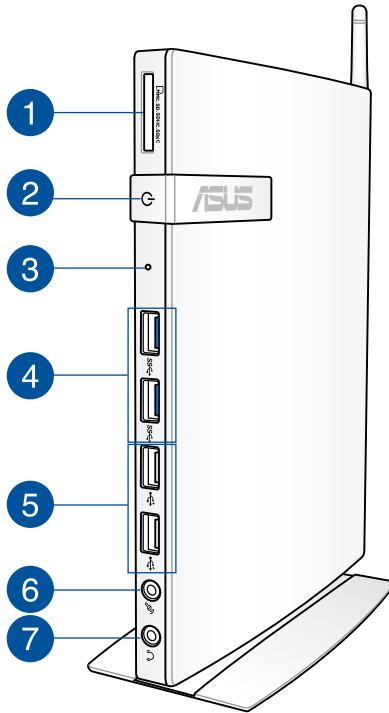

Memory card slot

The built-in memory card reader enables your PC to read and write data to and from MMC/SD/SDHC/SDXC cards.





Power switch

The power switch allows powering ON and OFF the system.

- 3 BIOS key**

Before booting up the system, insert a straightened paper clip into this hole to enter the BIOS.
- 4  USB 3.0 ports**

These USB (Universal Serial Bus) ports provide a transfer rate of up to 5 Gbit/s and are backward compatible with USB 2.0.
- 5  USB 2.0 ports**

The USB (Universal Serial Bus) 2.0 ports are compatible with USB 2.0/1.1 devices such as keyboards, mouse devices, cameras, and hard disk drives. USB allows many devices to run simultaneously on a single computer, with some peripheral acting as additional plug-in sites or hubs.
- 6  Microphone jack**

The microphone jack is designed to connect the microphone used for video conferencing, voice narrations, or simple audio recordings.
- 7  Headphone jack**

The stereo headphone jack (3.5mm) is used to connect the system's audio out signal to amplified speakers or headphones.

Rear view

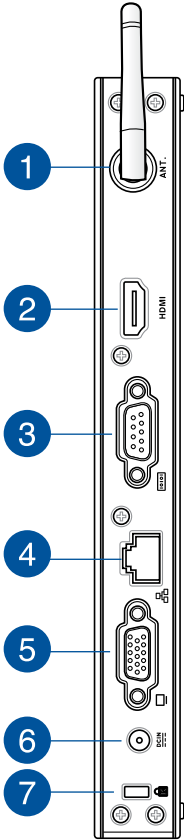







1



Wireless antenna jack (optional)

The jack is used to connect the supplied wireless antenna to enhance wireless signal reception.

- 2**  **HDMI** **HDMI port**
The HDMI (High Definition Multimedia Interface) port supports a Full-HD device such as an LCD TV or monitor to allow viewing on a larger external display.
- 3**  **Serial Port (COM Port)**
The 9-pin D-sub serial port supports native serial devices such as a serial drawing tablets, serial mouse, or serial modem.
- 4**  **LAN(RJ-45) port**
The eight-pin RJ-45 LAN port supports a standard Ethernet cable for connection to a local network.
- 5**  **Display (Monitor) Output**
The 15-pin D-sub monitor port supports a standard VGA-compatible device such as a monitor or projector to allow viewing on a larger external display.
- 6**  **Power input (DC 19V)**
The supplied power adapter converts AC power to DC power for use with this jack. Power supplied through this jack supplies power to the PC. To prevent damage to the PC, always use the supplied power adapter.
-
- WARNING!** The power adapter may become warm to hot when in use. Do not cover the adapter and keep it away from your body.
-
- 7**  **Kensington® lock port**
The Kensington® lock port allows you to secure your PC using Kensington® compatible PC security products.

Chapter 2: Using your PC

Positioning your PC

Mounting your PC on the stand

To mount your PC on the stand:

1. Locate the mounting hole at the bottom of your PC.
2. Align the stand's mounting hole with the mounting hole on your PC, then secure it in place with the stand screw.

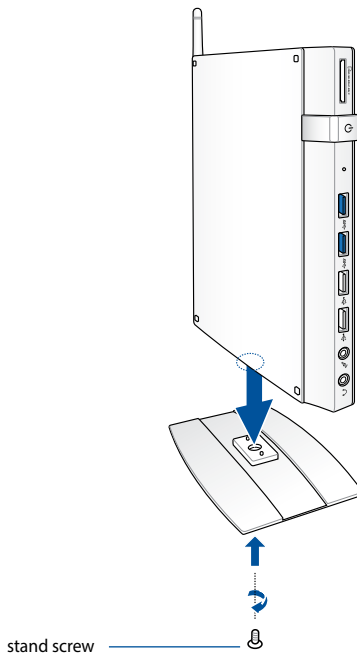

IMPORTANT! Ensure that your PC is mounted on its stand before placing it on a stable and flat surface.

Installing your PC to a monitor

To install your PC to a monitor:

1. Secure the VESA mount to your monitor* with four screws bundled with your VESA mount kit.

NOTE: Your monitor must comply with VESA75 or VESA100 standard.

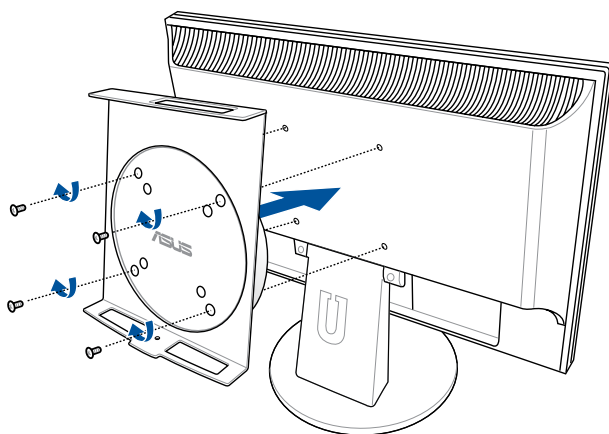

* The PC can be mounted on an ASUS VS228H monitor.

2. Align and place your PC into the VESA mount as shown.

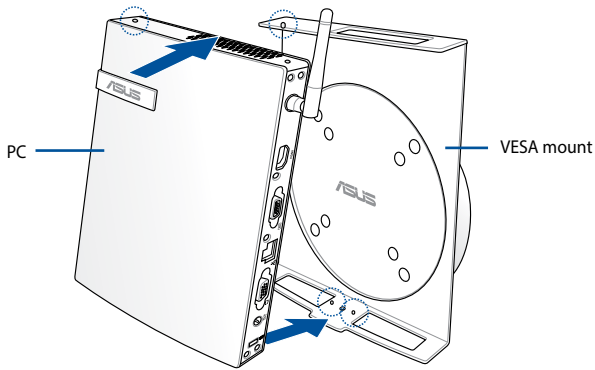

NOTE: Ensure that the ASUS trademark on the rotation wheel of the VESA mount is set to its customary position when putting in the PC so that the machine can rotate properly.

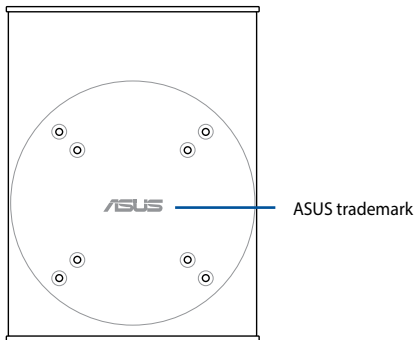

3. Secure the PC and the VESA mount assembly with a stand screw. Ensure that the PC is firmly attached to the VESA mount.

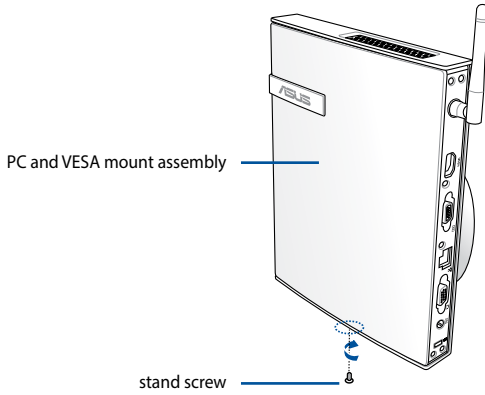

NOTE: Use the stand screw bundled with the stand.

4. To adjust the angle of the PC and VESA mount assembly to make the PC's front and rear more accessible, press the lever switch of the VESA mount to unlock the rotation wheel (A) then rotate the PC and VESA mount assembly accordingly (B).

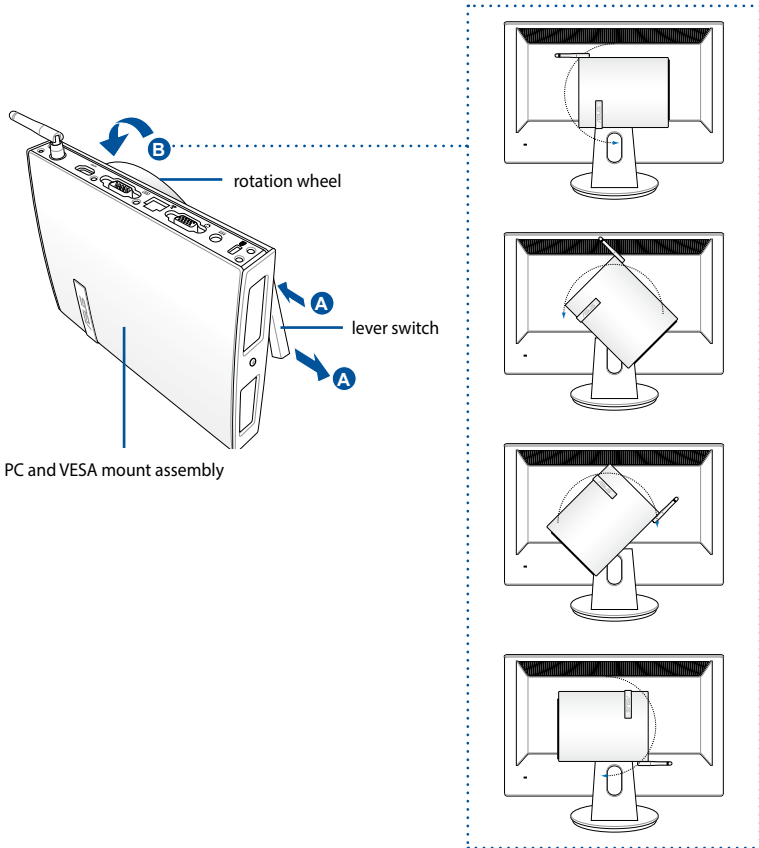

IMPORTANT!

- Set the rotation wheel upright when the system is in use.
- Please take note of the cables connected to the PC while operating the rotation wheel. To prevent hazards from loosened cables, the wheel is designed to rotate no more than 90° clock/counter-clockwise.

Using your PC

Connecting to an external display

Connect one end of an HDMI or a VGA cable to an external display, and the other end of the cable to your PC's HDMI or VGA port.

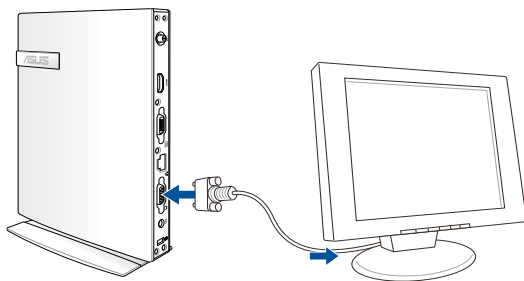

Connecting to a USB device

Connect USB devices like wired/wireless keyboards, mouse devices, and printers to the USB ports on your PC.

NOTE: The keyboard varies with country or region.

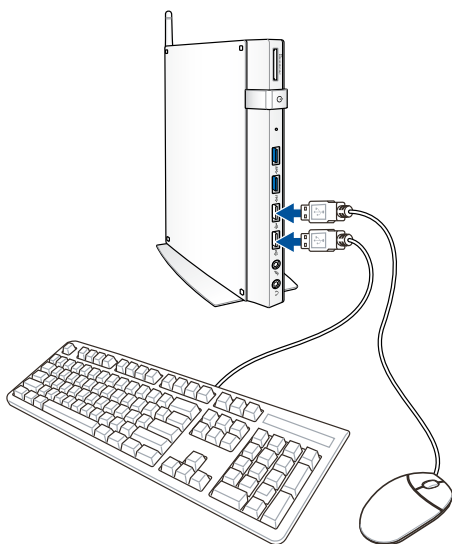

Connecting the wireless antenna (optional)

Connect the wireless antenna to your PC to enhance the wireless signal. Ensure that the wireless antenna is in an upright position (90° angle) to get the best wireless reception.

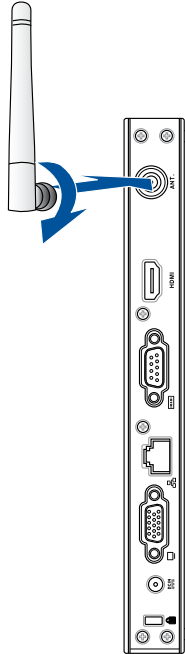

Turning on your PC

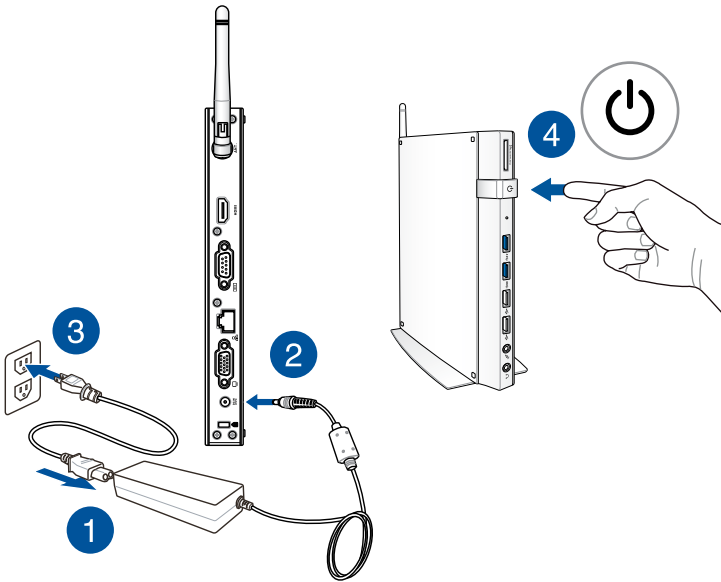

NOTES:

- When your PC is not in use, unplug the power adapter or switch off the power button to save on power consumption.
 - Adjust the power management settings in the Window® Control Panel. This is to ensure that your PC is set to a low power consumption mode and is fully operational at the same time.
-

Configuring the audio output via an HDMI device

If you want to use a high-definition TV as an audio output device, connect it to the Home Theater PC and follow the steps below to configure the audio settings.

To configure the audio output via an HDMI device:

- Do any of the following based on your PC's operating system.

On Windows® 7

Right-click the **Volume Mixer** icon on the Windows® notification area and click **Playback devices**.



On Windows® 8.1

- From the Start screen, click **Desktop** to launch the Desktop Mode.

NOTE: For more details, refer to the section *Start screen* under *Using Windows® 8.1*.

- Right-click the **Volume Mixer** icon on the Windows® taskbar and click **Playback devices**.



On Windows® 10

- From the Start screen, click **Desktop** to launch the Desktop Mode.
- Right-click the **Volume Mixer** icon on the Windows® taskbar and click **Playback devices**.



- From the Playback screen, select **Digital Audio (HDMI)**.
- Click **Configure** and the Speaker Setup window pops up.

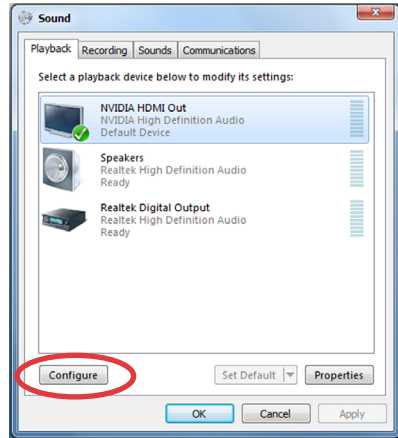

- Select **Stereo** and click **Next**.

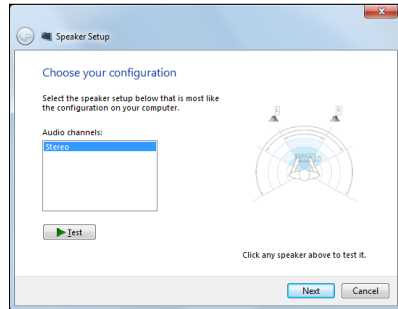



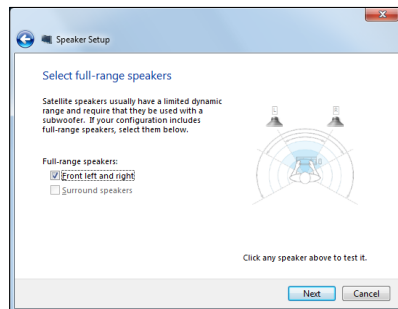















- Tick the **Front left and right** option, and click **Next**.
- Click **Finish** to exit the speaker setup.



Keyboard shortcuts

Using your keyboard, you can also use the following shortcuts to help you launch apps and navigate Windows® 10.

	Switches between the Start screen and the last running app
 + <D>	Launches the desktop
 + <E>	Launches File Explorer
 + <F> or  + <W>	Activates the File search function
 + <H>	Launches Share
 + <I>	Launches Settings
 + <K>	Launches Media Connect
 + <L>	Activates the Lock screen
 + <M>	Hides all currently active screens to the taskbar
 + <P>	Your desktop PC is mirrored to your secondary monitor
 + <Q>	Launches Cortana

 + <R>	Launches the Run window
 + <U>	Launches Ease of Access Center
 + <X>	Launches a menu box of Windows tools
 + <+>	Launches the magnifier and zooms in your screen.
 + <->	Zooms out your screen.
 + <Enter>	Opens the Narrator Settings.

Chapter 3: Working with Windows® 7

Starting for the first time

When you start your Mini Desktop PC for the first time, a series of screens appear to guide you in configuring the basic settings of your Windows® 7 operating system.

To start your Mini Desktop PC for the first time:

1. Turn on your Mini Desktop PC. Wait for a few minutes until the **Set Up Windows** screen appears.
2. From the dropdown list, select your preferred language then click **Next**.
3. From the dropdown lists, select your **Country or region, Time and currency**, and **Keyboard layout** then click **Next**.
4. Key in unique names for the **user name** and **Mini Desktop PC name** then click **Next**.
5. Key in the necessary information to set up your password, then click **Next**. You may also click **Next** to skip this step without entering any information.

NOTE: If you want to set up a password for your account later, refer to the *Setting up a user account and password* section in this user guide.

6. Carefully read the license terms. Tick **I accept the license terms** then click **Next**.
7. Select **Use recommended settings** or **Install important updates only** to set up the security settings of your Mini Desktop PC. To skip this step, select **Ask me later**.
8. Review your date and time settings. Click **Next**. The system loads the new settings then restarts.
9. After restarting, you may now start using your Mini Desktop PC.

Using the Start menu

The Start menu gives access to programs, utilities and other useful items on your Mini Desktop PC.

Launching items from the Start menu

1. From the Windows® taskbar, click .
2. From the Start menu, select the item that you want to launch.

NOTE: You may pin programs that you want constantly displayed on the Start menu. For more details, refer to the *Pinning programs on the Start menu or taskbar* section in this user guide.

Using Getting Started

The Getting Started option on the Start menu contains information on some basic tasks such as personalizing Windows®, adding new users, and transferring files to help you become more familiar with using Windows® 7.

To use Getting Started:

1. Click .
2. From the Start menu, select **Getting Started**.
3. From the list of available tasks, select the task that you want to do.

Using the taskbar

The taskbar allows you to launch and manage programs or items installed in your Mini Desktop PC.

Launching a program from the taskbar

From the Windows® taskbar, click an icon to launch it. Click the icon again to hide the program.

Pinning items on the jumplists

When you right-click an icon on the taskbar, a jumplist appears to provide quick-access to related links. You may pin items on the jumplist such as favorite websites, frequently visited folders or drives, and recently played media files.

To pin items on the jumplist:

1. Right-click an icon on the taskbar.
2. From the jumplist, right-click the item that you want to pin, then select **Pin to this list**.

Unpinning items from the jumplist

1. Right-click an icon on the taskbar.
2. From the jumplist, right-click the item you want to remove then select **Unpin from this list**.

Using the notification area

By default, the notification area shows these three icons:



Action Center notification

Click this icon to display all alerts and notifications. This also launches the Windows® Action Center.



Network connection

This icon displays the connection status and signal strength of the wired or wireless network connection.



Volume

Click this icon to adjust the volume of your Mini Desktop PC.

Displaying an alert notification

To display an alert notification, click  then click the message to open it.

NOTE: For more details, refer to the *Using Windows® Action Center* in this user guide.

Customizing icons and notifications

You may choose to display or hide icons and notifications on the taskbar or on the notification area.

To customize icons and notifications:

1. Click  on the notification area.
2. Click **Customize**.
3. From the dropdown list, select your preferred behavior for the icons or items you want to customize.

Using Windows® Explorer

Windows® Explorer allows you to view, manage, and organize your files folders.

Launching Windows® Explorer

Click  to launch the Start menu then click **Computer**.

Exploring files and folders

1. Launch Windows® Explorer.
2. From the navigation or view pane, browse for the location of your data.
3. Click the arrow on the breadcrumb bar to display to display the contents of the drive or folder.

Customizing the file or folder view

1. Launch Windows® Explorer.
2. Select the location of your data.
3. Click .
4. From the view menu, move the slider to select how you want to view the file or folder.

Arranging files

1. Launch Windows® Explorer.
2. From the **Arrange by** field, click to display the dropdown list.
3. Select your preferred arrangement type.

Sorting files

1. Launch Windows® Explorer.
2. Right-click anywhere on the View pane.
3. From the menu that appears, select **Sort by** then select your preferred sorting type.

Grouping files

1. Launch Windows® Explorer.
2. Right-click anywhere on the View pane.
3. From the menu that appears, select **Group by** then select your preferred grouping.

Adding a new folder

1. Launch Windows® Explorer.
2. From the toolbar, click **New folder**.
3. Key in a name for the new folder.

Backing up files

To set up a backup:

1. Click  > **All Programs > Maintenance > Backup and Restore.**
2. Click **Set up backup > Next.**
3. Select your backup destination then click **Next.**
4. Select **Let Windows choose (recommended)** or **Let me choose as your backup mode.**

NOTE: If you select **Let Windows choose**, Windows will not backup your programs, FAT-formatted files, Recycle Bin files, or temporary files that are 1GB or more.

5. Follow the onscreen instructions to finish the process.

Restoring your system settings

The Windows® System Restore feature creates a restore point the Mini Desktop PC's system settings are stored at a certain time and date. It allows you to restore or undo changes made to your Mini Desktop PC's system settings without affecting your personal data.

To restore your system:

1. Close all running applications.
2. Click  > **All Programs > Accessories > System Tools > System Restore.**
3. Follow the onscreen instructions to complete the process.

Using Windows® 7 Action Center

Windows® 7 Action Center provides alert notifications, security information, system maintenance information, and the option to automatically troubleshoot and fix some common Mini Desktop PC problems.

Launching Windows® 7 Action Center

1. Click  > **Open Action Center**.
2. Click the task that you want to do.

Using Windows® Update

Windows® update allows you to check and install the latest updates to enhance the security and performance of your Mini Desktop PC.

Launching Windows® Update

1. Click  to launch the Start menu.
2. Select **All Programs > Windows Update**.
3. Click the task that you want to do.

Setting up a user account and password

You may create user accounts and passwords for people to use on your Mini Desktop PC.

To set up a user account:

1. Click  > **Getting Started** > **Add new users**.
2. Select **Manage another account**.
3. Select **Create a new account**.
4. Type the user name.
5. Select either **Standard user** or **Administrator** as the user type.
6. Once finished, click **Create Account**.

To set up a password:

1. Select the user that you would like to set a password for.
2. Select **Create a password**.
3. Type your preferred password then confirm it.
4. Type a password hint.
5. Once finished, click **Create password**.

Using Windows® Help and Support

Windows® Help and Support provides you with guides and answers about using the applications included with your Windows® 7.

To launch Windows® Help and Support, click  > **Help and Support**.

NOTE: Conne^c to the Internet to get the latest Windows® online help.

Chapter 4: Working with Windows® 8.1

NOTE: The operating system varies with country or region.

System requirements

To facilitate a smoother transition from your previous operating system, read the system requirements below before upgrading to Windows® 8.1:

Processor	1GHz or faster
RAM	1GB (32-bit) or 2 GB (64-bit)
Hard disk space	16 GB (32-bit) or 20 GB (64-bit)
Graphics card	Microsoft DirectX9 graphics device with WDDM driver
Screen resolution	1024 x 768 for Windows® apps

NOTE:

For more information on how to update/upgrade to Windows® 8.1:

- If you are running Windows® 7, visit <http://www.windows.microsoft.com/en-us/windows-8/upgrade-to-windows-8>
 - If you are running Windows® 8, visit <http://www.windows.microsoft.com/en-us/windows-8/update-from-windows-8-tutorial>
-

Starting for the first time

When you start your computer for the first time, a series of screens appear to guide you in configuring the basic settings of your Windows® 8.1 operating system.

To start for the first time:

1. Turn your computer on. Wait for a few minutes until the setup screen appears.
2. Carefully read the license terms. Tick **I accept the license terms for using Windows** and click **Accept**.
3. Follow the next onscreen instructions to configure the following basic items:
 - Personalize
 - Wireless
 - Settings
 - Sign in to your PC
4. Once you are done configuring the basic items, the Windows® 8.1 video tutorial appears. Watch this tutorial to learn more about Windows® 8.1 functionalities.
5. The Start screen appears after successfully signing in to your user account.

Windows® 8.1 lock screen

The Windows® 8.1 lock screen may appear when your PC enters the Windows® 8.1 operating system. To proceed, tap on the lock screen or press any key on your PC 's keyboard.

Windows® UI

The Windows® User interface (UI) is the tile-based display used in Windows® 8.1. It includes the following features you can use while working on your PC.

Start Screen

The Start Screen appears after successfully signing in to your user account. It helps organize all the programs and applications you need in just one place.

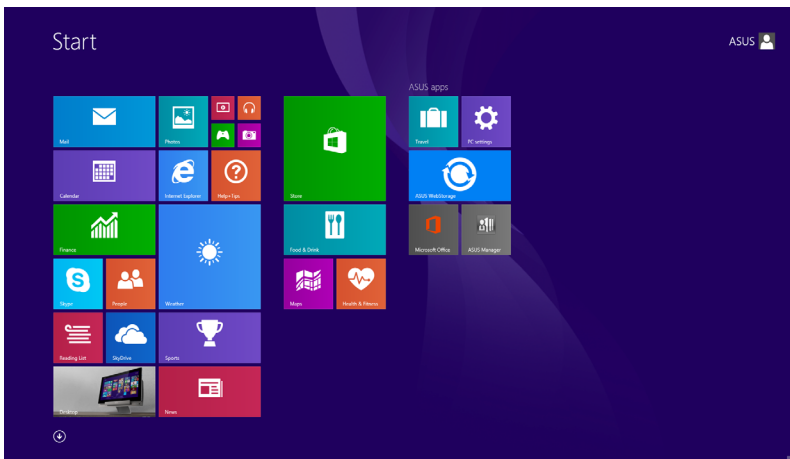

NOTE: Actual apps shown onscreen may vary per model. The following screenshot is for reference only.

Windows® apps

These are apps pinned on the Start screen and displayed on tiled-format for easy access.

NOTE: Some apps require signing in to your Microsoft account before they are fully launched.

Hotspots

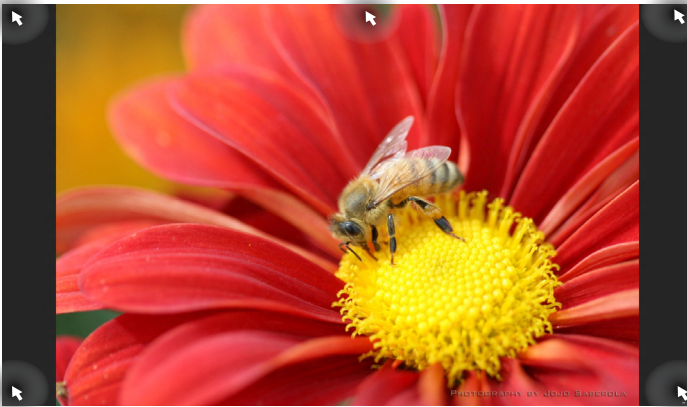

Onscreen hotspots allow you to launch programs and access the settings of your PC. The functions in these hotspots can be activated using your mouse.

Hotspots on a running app

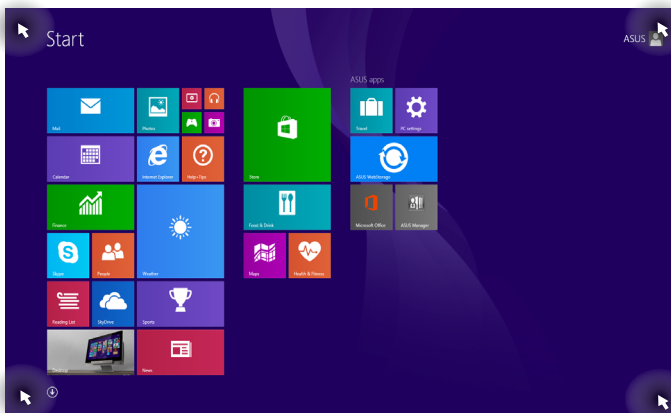

Hotspots on the Start screen



Hotspot	Action
upper left corner	Hover your mouse pointer then tap on the recent app's thumbnail to revert back to that running app. <hr/> <p>If you launched more than one app, slide down to show all running apps.</p>
lower left corner	From a running app screen: Hover your mouse pointer then click  to go back to the Start screen. <hr/> <p>NOTE: You can also press the Windows key  on your keyboard to go back to the Start screen.</p> From the Start screen: Hover your mouse pointer then click  to go back to that app.
top	Hover your mouse pointer until it changes to a hand icon. Drag then drop the app to a new location. <hr/> <p>NOTE: This hotspot function only works on a running app or when you want to use the Snap feature. For more details, refer to <i>Snap feature</i> under <i>Working with Windows® apps</i>.</p>
upper and lower right corner	Hover your mouse pointer to launch the Charms bar.

Start button

Windows® 8.1 features the Start button which allows you to switch between the two most recent apps you opened. The Start button may be accessed from the Start screen, while on Desktop mode, and on any app that is currently open onscreen.

Start button on the Start screen

NOTE: The actual color of your Start button varies depending on the display settings you chose for your Start screen.

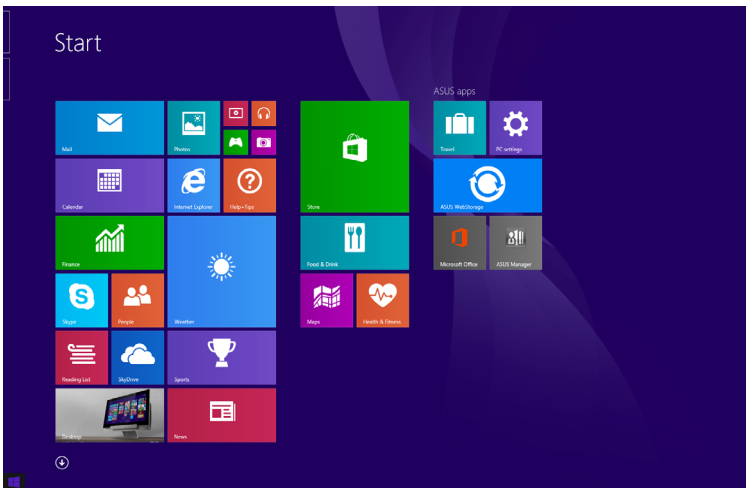

Hover your mouse pointer over the left corner of your Start screen or any opened app to call out the Start button.

Start button on Desktop mode



Context menu

The context menu appears as a box filled with quick access to some of the programs inside Windows® 8.1 when you right-click on the Start button.

The context menu also includes the following shut down options for your PC: sign out, sleep, shut down, restart.

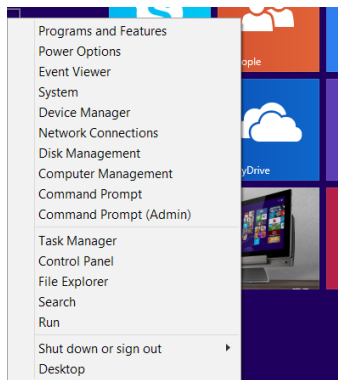

Customizing your Start screen

Windows® 8.1 enables you to customize your Start screen, allowing you to boot directly to the Desktop mode and customize the arrangement of your apps onscreen.

To customize the settings of your Start screen:

1. Launch the **Desktop**.
2. Right-click anywhere on the taskbar, except on the Start button, to launch the **Taskbar and Navigation properties** window.
3. Select the **Navigation** tab then tick the options you want to use.

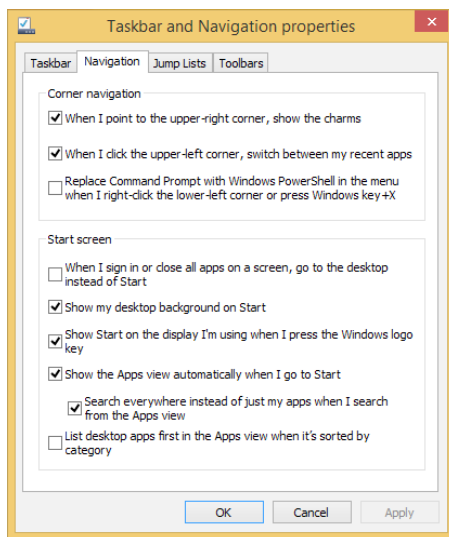



4. Click **Apply** to save the new settings then exit.

Working with Windows® apps

Use your PC's keyboard or mouse to launch and customize your apps.

Launching apps

- Using your mouse, position the mouse pointer on an app then left-click once to launch it.
- Using your keyboard, press  until an app is selected then use the arrow keys to browse through the apps. Press  to launch your selected app.

Customizing apps from the Start screen

You can move, resize, or unpin apps from the Start screen using the following steps.

Moving apps

To move an app, point and drag it to a new location.



Resizing apps

Right-click the app to activate its settings bar then tap  and select an app tile size.

Unpinning apps

To unpin an app from the Start screen, right-click on the app to activate its settings bar then tap .

Closing apps

- Move the mouse pointer on the top side of the launched app then wait for the pointer to change to a hand icon. Drag then drop the app to the bottom of the screen to close it.
- From the running app's screen, press  + .

Accessing the Apps screen

Aside from the apps already pinned on your Start screen, you can also open other applications through the Apps screen.

NOTE: Actual apps shown onscreen may vary per model. The following screenshot is for reference only.

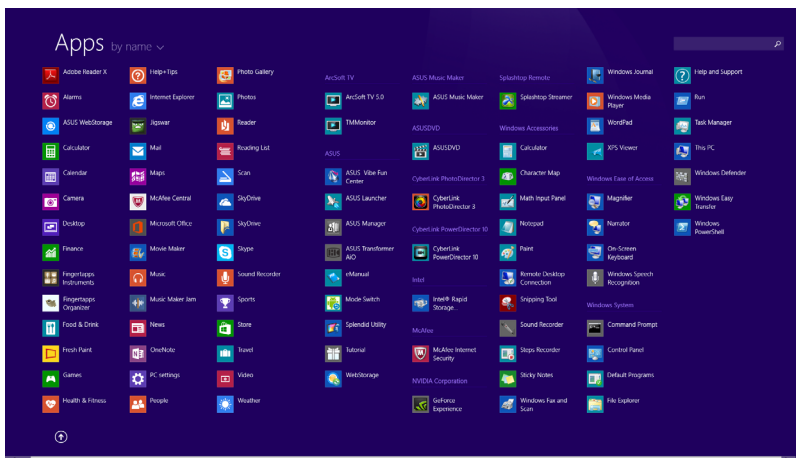



Horizontal scroll bar

Launching the Apps screen

Launch the Apps screen using a mouse or a keyboard.

Using your mouse, click the  button.

Using your keyboard, from the Start screen, press , then press .

Pinning more apps on the Start screen

1. Launch the All Apps screen.
2. Right-click on the apps that you want to pin on the Start screen.
3. Click on the  icon to pin the selected apps on the Start screen.

Charms bar

The Charms bar is a toolbar that can be triggered on the right side of your screen. It consists of several tools that allow you to share applications and provide quick access for customizing the settings of your PC.

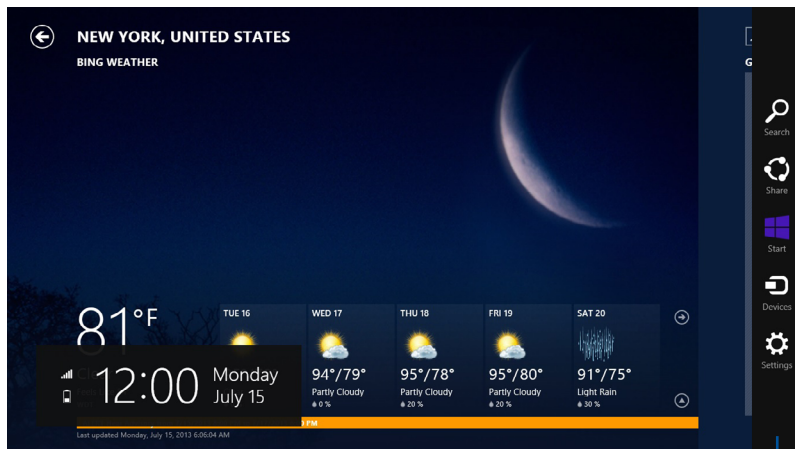



Charms Bar

Launching the Charms bar

NOTE: When called out, the Charms bar initially appears as a set of white icons. The image above shows how the Charms bar looks like once activated.

Use your PC's mouse or keyboard to launch the Charms bar:

- Move your mouse pointer on the upper or lower right corner of the screen.
- Press  + .

Inside the Charms bar



Search

This tool allows you to look for files, applications, or programs in your PC.



Share

This tool allows you to share applications via social networking sites or email.



Start

This tool reverts the display back to the Start screen. From the Start screen, you can also use this to revert back to a recently opened app.



Devices

This tool allows you to access and share files with the devices attached to your PC such as an external display or printer.



Settings

This tool allows you to access the PC settings of your PC.

Snap feature

The Snap feature displays two apps side-by-side, allowing you to work or switch between apps.

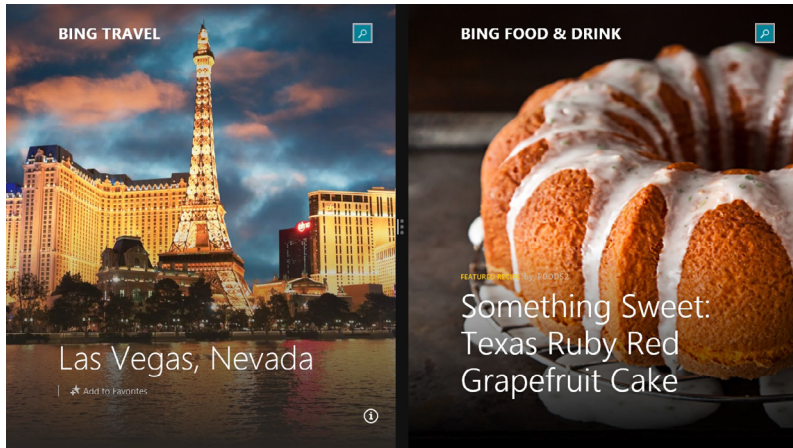

Snap bar

Using Snap

Perform the following steps to activate Snap using your PC's mouse or keyboard.

Using your mouse

1. Launch the app you wish to snap.
2. Hover the mouse point on the top side of your screen.
3. Once the pointer changes to a hand icon, drag then drop the app to the left or right side of the display panel.
4. Launch another app. This app is automatically placed on the available pane.

Using your keyboard

1. Launch the app you wish to snap.
2. Press  and the left or right arrow key to snap the app to the left or right pane.
3. Launch another app. This app is automatically placed on the available pane.

Other keyboard shortcuts

Using the keyboard, you can also use the following shortcuts to help you launch applications and navigate Windows®8.1.



Switches between the Start screen and the last running app

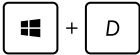

Launches the desktop

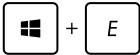

Launches the **This PC** window on Desktop mode



Opens the **File** option from the **Search** charm



Opens the **Share** charm

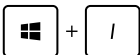

Opens the **Settings** charm

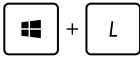

Activates the Lock screen

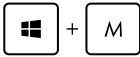

Minimizes all currently active windows

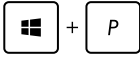

Launches the **Project** pane

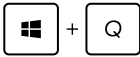

Opens the **Everywhere** option from the **Search** charm



Opens the **Run** window

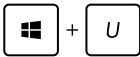

Opens **Ease of Access Center**

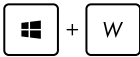

Opens the **Settings** option from the **Search** charm

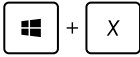

Opens a context menu of the Start button

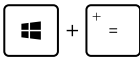

Launches the magnifier icon and zooms in your screen



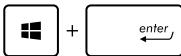

Zooms out your screen



Opens the **Narrator** Settings

Turning your PC off

You can shut down your PC by doing either of the following procedures:

- Hover on the lower left corner of your screen to launch the Start Button, then right-click on it. In the context menu, select **Shutdown or signout > Shut down**.
- Click  from the Charms bar then click  > **Shut down** to do a normal shutdown.
- From the log-in screen, click  > **Shut down**.
- If your PC is unresponsive, press and hold the power button for at least four (4) seconds until your PC turns off.
- To shut down your PC using Desktop mode, launch the desktop then press *alt + f4* to launch the **Shut Down** window. Select **Shut Down** from the drop-down list then select **OK**.

Putting your PC to sleep

You activate sleep mode on your PC using the following procedures.

- Press the Power button once.
- To put your PC to sleep mode using Desktop mode, launch the desktop then press *alt + f4* to launch the Shut Down window. Select **Sleep** from the drop-down list then select **OK**.

Entering the BIOS Setup

BIOS (Basic Input and Output System) stores system hardware settings that are needed for system startup in the PC.

In normal circumstances, the default BIOS settings apply to most conditions to ensure optimal performance. Do not change the default BIOS settings except in the following circumstances:

- An error message appears on the screen during the system bootup and requests you to run the BIOS Setup.
- You have installed a new system component that requires further BIOS settings or update.

WARNING! Inappropriate BIOS settings may result to instability or boot failure. We strongly recommend that you change the BIOS settings only with the help of a trained service personnel.

Quickly enter the BIOS

To access the BIOS before the PC boots into the OS, try any of the following:

- Before booting up the system, insert a straightened paper clip into the BIOS key.

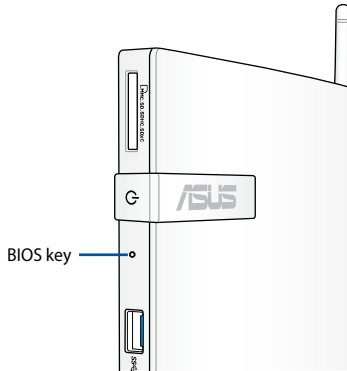

- Press the power button for at least four seconds to shut down your PC, then press the power button again to turn your PC back on, and press <F2> during POST.
- When your PC is off, disconnect the power cord from your PC's power connector. Reconnect the power cord and press the power button to turn on your PC. Press <F2> during POST.

NOTE: POST (Power-On Self Test) is a series of software controlled diagnostic tests that run when you turn on your PC.

Chapter 5: Working with Windows® 10

Starting for the first time

When you start your computer for the first time, a series of screens appear to guide you in configuring the basic settings of your Windows® 10 operating system.

To start your Desktop PC for the first time:

1. Press the power button on your Desktop PC. Wait for a few minutes until the setup screen appears.
2. From the setup screen, pick your region and language that you want to use on your desktop PC.
3. Carefully read the License Terms, then tap **I Accept**.
4. Follow the onscreen instructions to configure the following basic items:
 - Personalize
 - Get online
 - Settings
 - Your account
5. Wait until Windows® 10 finishes installing the apps and system settings. After the installation, the Windows® 10 desktop appears.

Using the Windows® 10 UI

The Windows® 10 User Interface (UI) includes the favorite Start menu and the tiled-format on the Start screen. It includes the following features you can use while working on your Desktop PC.

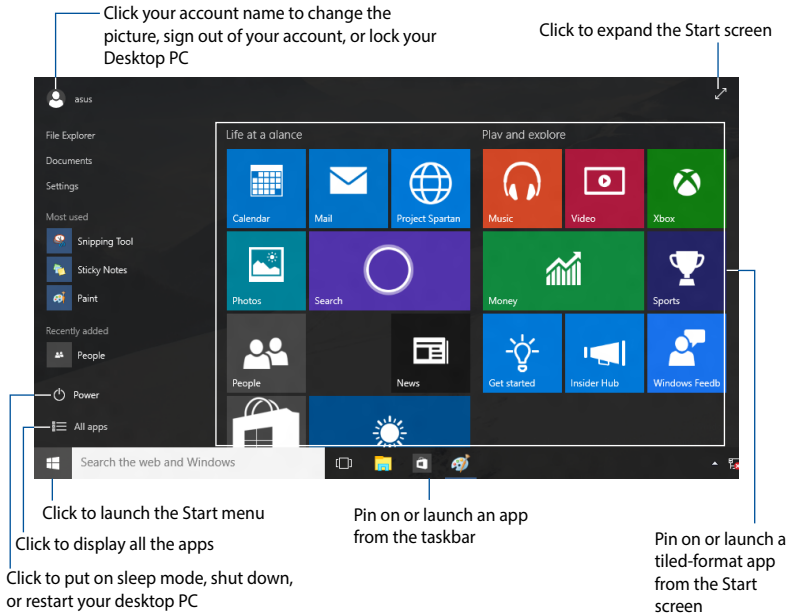

Start menu

Windows® 10 brings back the Start menu with some enhancements, such as the space that you can customize with your favorite apps, people, or websites.

You can launch the Start menu in two ways:

- Click the Start button from the lower-left corner of the taskbar.
- Press the Windows® Start key  on your keyboard.

Pinning apps to the Start screen or taskbar

To pin an app to the Start screen or taskbar:

1. From the Start menu, click **All apps**, then select the app that you want to pin.
2. Click **Pin to Start** or **Pin to taskbar** to pin your selected app to the Start screen or taskbar. You can also drag then drop an app to the Start Screen or taskbar to pin it.

Start screen

The Start screen, which appears together with the Start menu, helps organize all the apps you need in just one place. The apps on the Start screen are displayed on tiled-format for easy access.

NOTE: Some apps require signing in to your Microsoft account before they are fully launched.

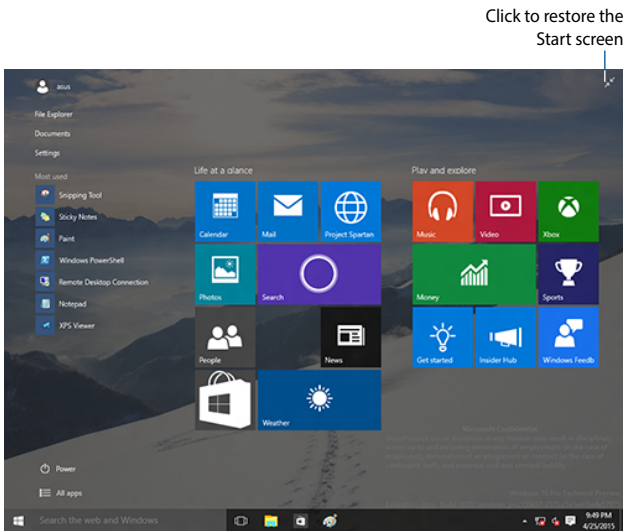

Moving apps on the Start screen

You can move apps from the Start screen simply through dragging and dropping the app to your preferred location.

Unpinning apps from the Start screen

To unpin an app from the Start screen, right-click on the app to activate its settings bar then click **Unpin from Start**.

Taskbar

Windows® 10 comes with the standard taskbar, which stores all your currently running apps or items in the background.

Unpinning apps from the taskbar

1. From the Start screen or taskbar, right-click the app you want to unpin.
2. Click **Unpin from Start** or **Unpin this program from taskbar** to remove the app from the Start screen or taskbar.

Using the Task View

When you have several running apps, you can click  from the taskbar to display all your running apps, and click on an app or item to launch it.

If task view is disabled, click  > **Show Task View button** to display the task view icon .

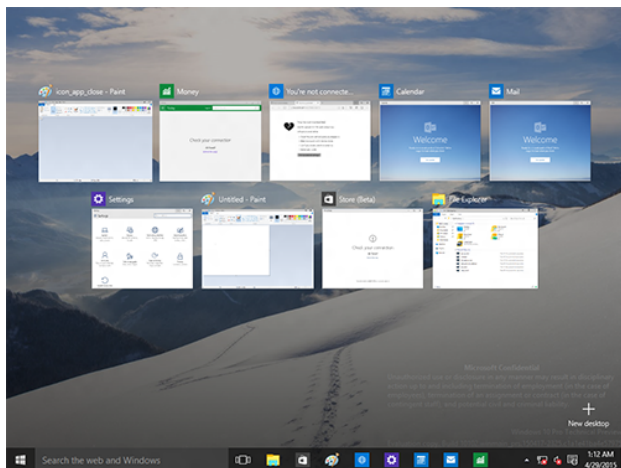

Snap feature

The Snap feature displays about four apps or more in one screen, allowing you to work or switch among apps.

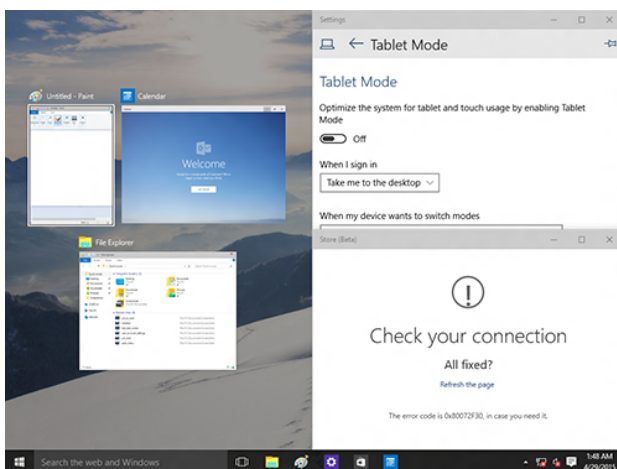



Using Snap

Use your Desktop PC's mouse or keyboard to activate Snap onscreen.

Using your mouse

- a) Launch an app, then drag and release on a screen corner to snap it in place.
- b) Snap another app to your preferred location on the screen.

Using your keyboard

- a) Launch an app, press  and the arrow keys to select the direction where you want to snap the app in place.
- b) Snap another app using  and the arrow keys.

Chapter 6: Connecting to the Internet

Access emails, surf the Internet, and share applications via social networking sites on or from your PC using wireless/Wi-Fi or wired connection.

Connecting on Windows® 7

Wireless connection

1. Click the wireless network icon  in the Windows® notification area.

WARNING! For security concerns, DO NOT connect to an unsecured network.

2. Select the wireless access point you want to connect to from the list and click **Connect** to build the connection.

NOTES: If you cannot find the desired access point, click the **Refresh** icon  on the upper right corner to refresh and search in the list again.

3. When connecting, you may have to enter a password.
4. After a connection has been established, the connection is shown on the list.
5. You can see the wireless network icon  in the Notification area.

Wired connection

1. Use a network (RJ-45) cable to connect your PC to a DSL/cable modem or a local area network (LAN).

DSL/Cable Modem

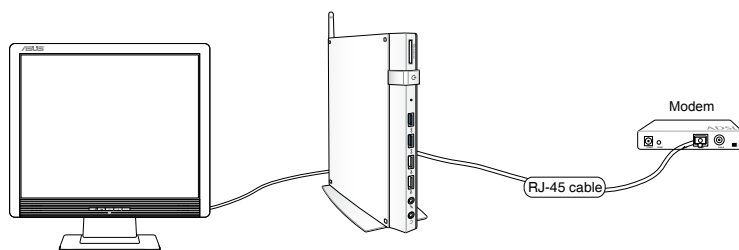

LAN

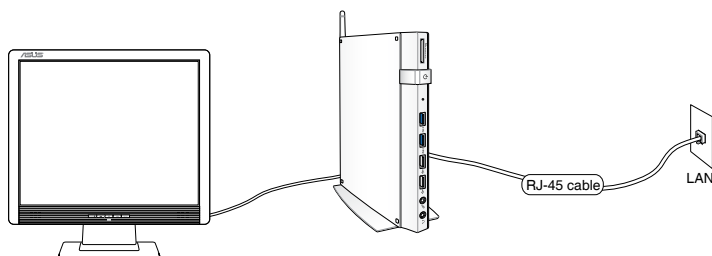

2. Configure a dynamic IP/PPPoE or static IP network connection.

NOTE: For more details, refer to the next sections.

Configuring an IP / PPPoE network connection

To configure your IP/PPPoE network connection:

1. Click the network icon  in the Windows® Notification area and select **Open Network and Sharing Center**.
2. Click **Change adapter settings** in the left blue pane.

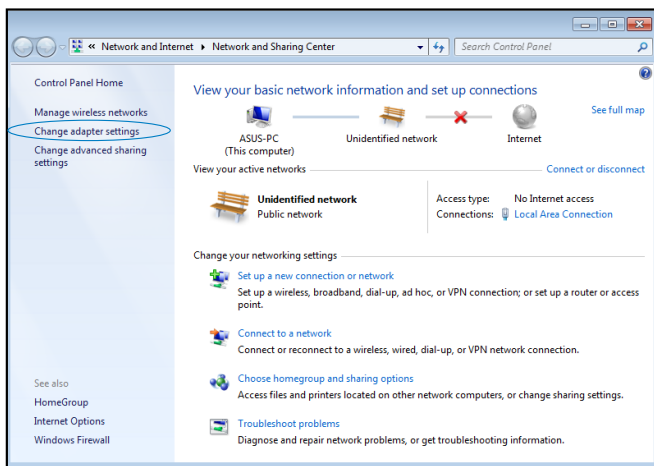

3. Right-click **Local Area Connection** and select **Properties**.
4. Click **Internet Protocol Version 4(TCP/IPv4)** and click **Properties**.

5. Configure the type of IP address for network configuration.

To configure using a dynamic IP address:

- a. Click **Obtain an IP address automatically** and click **OK**.
- b. Proceed to Step 6 if you are using PPPoE connection.

To configure using a static IP address:



- a. Click **Use the following IP address**.
 - b. Enter the IP address, Subnet mask and Gateway from your service provider.
 - c. If needed, enter the preferred DNS Server address and alternative address.
 - d. When done, click **OK**.
6. Return to the **Network and Sharing Center** and then click **Set up a new connection or network**.
 7. Select **Connect to the Internet** and click **Next**.
 8. Select **Broadband (PPPoE)** and click **Next**.
 9. Enter your User name and, Password, and Connection name. Click **Connect**.
 10. Click **Close** to finish the configuration.
 11. Click the network icon in the taskbar and click the connection you just created.
 12. Enter your user name and password. Click **Connect** to connect to the Internet.

Connecting on Windows® 8.1

Wi-Fi connection

1. Launch the Charms bar.

NOTE: For details, refer to the section *Charms bar* under *Working with Windows® apps*.

2. From the Charms bar, click  and click the  .
3. Select a wireless network from the list of available Wi-Fi connections.
4. Click **Connect** to start the network connection.

NOTE: You may be prompted to enter a security key to connect to a secured wireless network.

5. (Optional) To enable sharing between your PC and other wireless-enabled systems, click **Yes**. Click **No** if you do not want to enable the sharing function.

Wired connection

You can connect your PC to a local area network (LAN) or broadband Internet connection using a network cable.

To connect your PC to a LAN connection using a network cable:

1. Connect one end of the network cable (RJ-45) to your PC's LAN port and the other end to the DSL/cable modem or a local area network (LAN) port.

DSL/Cable Modem

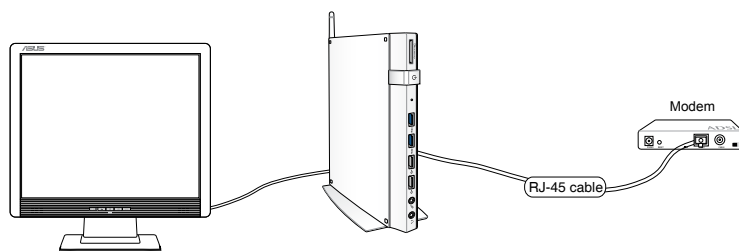

LAN

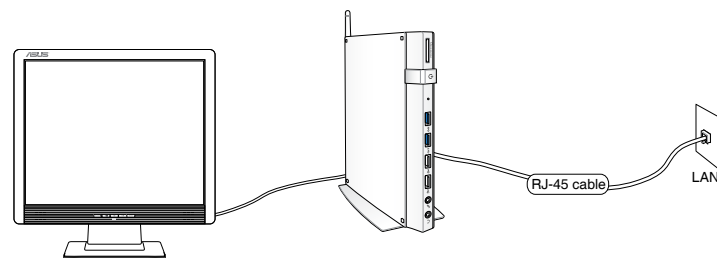

2. Launch the **Desktop**.
3. From the Windows® taskbar, right-click the network icon  then click **Open Network and Sharing Center**.
4. In the Network and Sharing Center window, click **Change adapter settings**.

5. Right-click on the LAN controller then select **Properties**.
6. Click **Internet Protocol Version 4(TCP/IPv4)** then click Properties.
7. Configure the type of IP address for network configuration.

To configure using a dynamic IP address:

- a. Click **Obtain an IP address automatically** then click **OK**.
- b. Proceed to step 8.

To configure using a static IP address:

- a. Click **Use the following IP address**.
 - b. Type the IP address, Subnet mask and Default gateway from your service provider.
 - c. If needed, you can also type the preferred DNS server address and alternate DNS server address then click **OK**.
 - d. Proceed to step 8.
8. Return to the **Network and Sharing Center** window then click **Set up a new connection or network**.
 9. Select **Connect to the Internet** then click **Next**.
 10. Click **Broadband (PPPoE)**.
 11. Key-in your User name, Password, and Connection name then click **Connect**.
 12. Click **Close** to finish the configuration.
 13. Click  on the taskbar then click the connection you just created.
 14. Key-in your user name and password then click **Connect** to start connecting to the Internet.

Connecting on Windows® 10

Wi-Fi connection

1. Click the wireless network icon  in the Windows® notification area.

WARNING! For security concerns, DO NOT connect to an unsecured network.

2. Select the wireless access point you want to connect to from the list and click **Connect** to build the connection.

NOTES: If you cannot find the desired access point, click the **Refresh** icon  on the upper right corner to refresh and search in the list again.

3. When connecting, you may have to enter a password.
4. After a connection has been established, the connection is shown on the list.
5. You can see the wireless network icon  in the Notification area.

Wired connection

1. Use a network (RJ-45) cable to connect your PC to a DSL/cable modem or a local area network (LAN).

DSL/Cable Modem

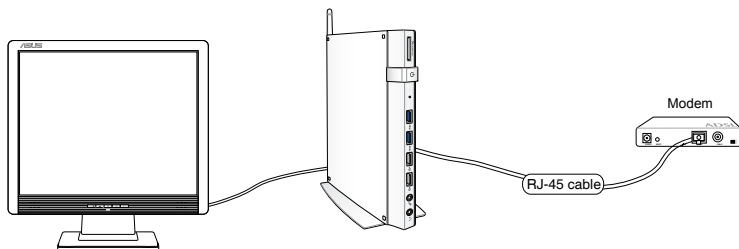

LAN

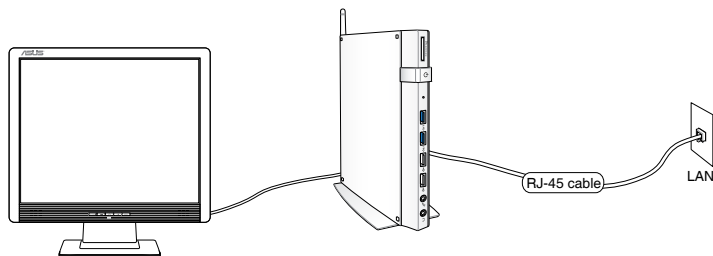

2. Configure a dynamic IP/PPPoE or static IP network connection.

NOTE: For more details, refer to the next sections.

Configuring a dynamic IP/PPPoE network connection

- Do either of these two ways to launch **Network and Sharing Center**.
 - From the taskbar, right-click , then click **Open Network and Sharing Center**.
 - From the Start menu, click **Settings > Network & Internet > Ethernet > Network and Sharing Center**.
- From the Open Network and Sharing Center screen, click **Change Adapter settings**.
- Right-click on your LAN and select **Properties**.
- Click **Internet Protocol Version 4(TCP/IPv4)** and click **Properties**.

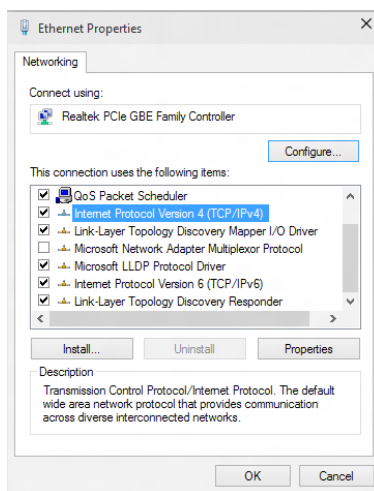

5. Click **Obtain an IP address automatically** and click **OK**.

NOTE: Continue to the next steps if you are using PPPoE connection.

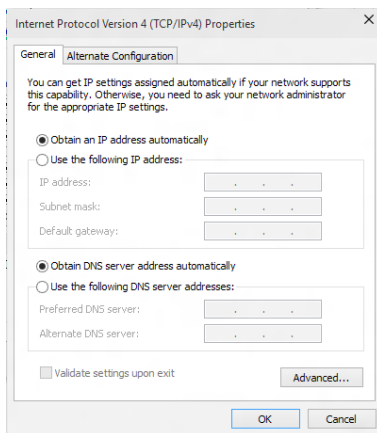

7. Return to the **Network and Sharing Center** and then click **Set up a new connection or network**.

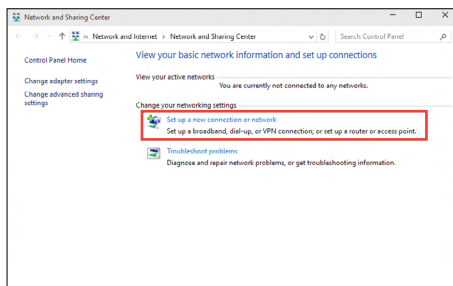

8. Select **Connect to the Internet** and click **Next**.

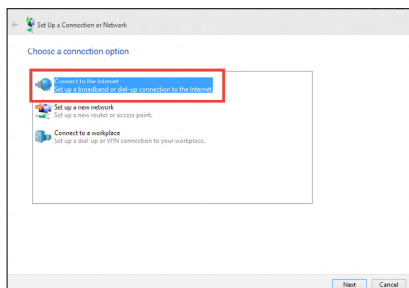

9. Select **Broadband (PPPoE)** and click **Next**.
10. Follow the next onscreen instructions to complete the setup.

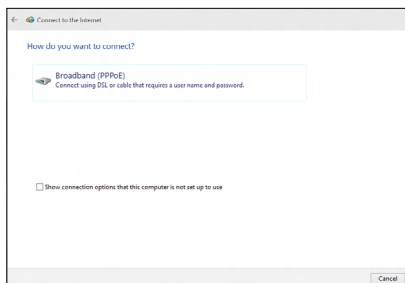

Configuring a static IP network connection

1. Repeat steps 1 to 4 of the previous section.
2. Click **Use the following IP address**.
3. Enter the IP address, Subnet mask and Gateway from your service provider.
4. If needed, enter the preferred DNS Server address and alternative address.
5. When done, click **OK**.

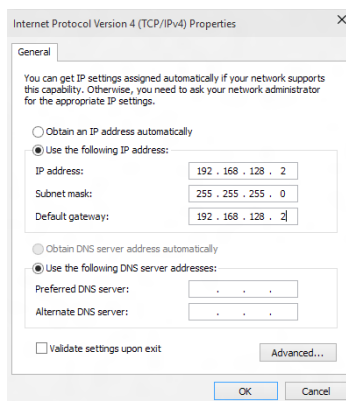

Chapter 7: Recovering your system

Recovery options on Windows® 7

Using the Recovery Partition

The Recovery Partition quickly restores your PC's software to its original working state. Before using the Recovery Partition, copy your data files (such as Outlook PST files) to USB storage devices or to a network drive and make note of any customized configuration settings (such as network settings).

The Recovery Partition is a reserved space on your hard disk drive used to restore the operating system, drivers, and utilities installed on your PC at the factory.

Recovering the OS to the factory default partition (F9 Recovery)

WARNING! DO NOT delete the partition named "RECOVERY." The recovery partition is created at the factory and cannot be restored by the user if deleted. Take your system to an authorized ASUS service center if you have problems with the recovery process.

To recover the OS to the factory default partition (F9 Recovery):

1. Press <F9> during bootup.
2. Select Windows setup [**EMS Enabled**] when this item appears and press [Enter].
3. Select the language and click **Next**.
4. Select **Recover the OS to the Default Partition** and click **Next**.
5. The factory default partition will be displayed. Click **Next**.

6. Data on the default partition will be cleared. Click **Recover** to start the system recovery.

NOTE: You will lose all your data on the selected partition. Ensure that you back up your important data.

7. When the recovery is completed successfully, click **Reboot** to restart the system.

Backing up the factory default environment data to a USB drive (F9 Backup)

To back up the factory default environment data to a USB drive (F9 Backup):

1. Press <**F9**> during bootup.
2. Select Windows setup [**EMS Enabled**] when this item appears and press [Enter].
3. Select the language and click **Next**.
4. Select **Recover the OS to the Default Partition** and click **Next**.
5. Select **Backup the Factory Environment to a USB Drive** and click **Next**.
6. Connect a USB storage device to your PC to start the Factory Default Environment backup.

NOTE: The required size of the connected USB storage device should be larger than 15GB. The actual size may vary with your PC model.

7. Select a desired USB storage device if more than one USB storage device is connected to your EeeTop PC/EeeBox PC and click **Next**.

NOTE: If there is already a partition with proper size in the selected USB storage device (for example, a partition that has been used as the backup partition), the system will show this partition automatically and reuse it for backup.

8. Based on the different situations in the previous step, data on the selected USB storage device or on the selected partition will be cleared. Click **Backup** to start backup.

NOTE: You will lose all your data on the selected USB storage device or on the selected partition. Ensure that you back up your important data.

9. When the back up is completed successfully, click **Reboot** to restart the system.

Recovery options on Windows® 8.1

Removing everything and reinstalling Windows

The **Remove everything and reinstall Windows** option in PC Settings restores your PC to its original factory settings. To do this:

IMPORTANT! Back up all your data before using this option.

NOTE: This process may take a while to complete.

1. Launch the **Charms bar**.
2. Click **Settings > Change PC Settings > Update and Recovery > Recovery**.
3. From the **Remove everything and reinstall Windows** option, click **Get Started**.
4. Follow the onscreen instructions to complete the reinstallation and reset process.

Recovery options on Windows® 10

Removing everything and reinstalling Windows®

Restoring your PC to its original factory settings can be done using the Remove everything and reinstall options in PC Settings. Refer to the steps below to use this option.

IMPORTANT! Back up all your data before using this option.

NOTE: This process may take a while to complete.

1. From the Start menu, click **Settings > Update & security > Recovery**.
2. Scroll down to view the **Remove everything and reinstall Windows** option. Under this option, click **Get started**.

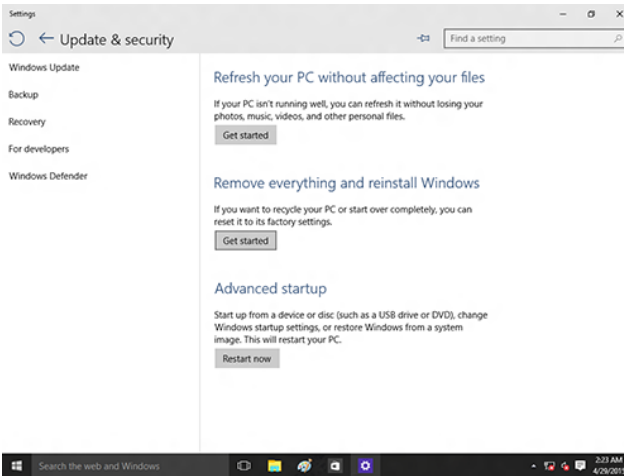

3. Follow the onscreen instructions to complete the reinstallation and reset process.

Appendices

Regulatory notices

REACH

Complying with the REACH (Registration, Evaluation, Authorization, and Restriction of Chemicals) regulatory framework, we publish the chemical substances in our products at ASUS REACH website at <http://csr.asus.com/english/REACH.htm>

ASUS Recycling/Takeback Services

ASUS recycling and takeback programs come from our commitment to the highest standards for protecting our environment. We believe in providing solutions for you to be able to responsibly recycle our products, batteries, other components, as well as the packaging materials. Please go to <http://csr.asus.com/english/Takeback.htm> for the detailed recycling information in different regions.

COATING NOTICE

IMPORTANT! To provide electrical insulation and maintain electrical safety, a coating is applied to insulate the device except on the areas where the I/O ports are located.

Federal Communications Commission Statement

This device complies with Part 15 of the FCC Rules. Operation is subject to the following two conditions:

- This device may not cause harmful interference, and
- This device must accept any interference received including interference that may cause undesired operation.

This equipment has been tested and found to comply with the limits for a Class B digital device, pursuant to Part 15 of the FCC Rules. These limits are designed to provide reasonable protection against harmful interference in a residential installation. This equipment generates, uses and can radiate radio frequency energy and, if not installed and used in accordance with manufacturer's instructions, may cause harmful interference to radio communications.

However, there is no guarantee that interference will not occur in a particular installation. If this equipment does cause harmful interference to radio or television reception, which can be determined by turning the equipment off and on, the user is encouraged to try to correct the interference by one or more of the following measures:

- Reorient or relocate the receiving antenna.
- Increase the separation between the equipment and receiver.
- Connect the equipment to an outlet on a circuit different from that to which the receiver is connected.
- Consult the dealer or an experienced radio/TV technician for help.

CAUTION! Any changes or modifications not expressly approved by the grantee of this device could void the user's authority to operate the equipment.

RF exposure warning

This equipment must be installed and operated in accordance with provided instructions and the antenna(s) used for this transmitter must be installed to provide a separation distance of at least 20 cm from all persons and must not be co-located or operating in conjunction with any other antenna or transmitter. End-users and installers must be provide with antenna installation instructions and transmitter operating conditions for satisfying RF exposure compliance.

ISED Radiation Exposure Statement for Canada

This equipment complies with ISED radiation exposure limits set forth for an uncontrolled environment. To maintain compliance with ISED RF exposure compliance requirements, please avoid direct contact to the transmitting antenna during transmitting. End users must follow the specific operating instructions for satisfying RF exposure compliance.

Operation is subject to the following two conditions:

- This device may not cause interference and
- This device must accept any interference, including interference that may cause undesired operation of the device.

Compliance Statement of Innovation, Science and Economic Development Canada (ISED)

This Class B digital apparatus complies with Canadian ICES-003, RSS-210, and CAN ICES-3(B)/NMB-3(B).

This device complies with Industry Canada license exempt RSS standard(s). Operation is subject to the following two conditions: (1) this device may not cause interference, and (2) this device must accept any interference, including interference that may cause undesired operation of the device.

Déclaration de conformité de Innovation, Sciences et Développement économique Canada (ISED)

Cet appareil numérique de classe B est conforme aux normes canadiennes ICES-003, RSS-210 et CAN ICES-3(B)/NMB-3(B).

Cet appareil est conforme aux normes CNR exemptes de licence d'Industrie Canada. Le fonctionnement est soumis aux deux conditions suivantes : (1) cet appareil ne doit pas provoquer d'interférences et (2) cet appareil doit accepter toute interférence, y compris celles susceptibles de provoquer un fonctionnement non souhaité de l'appareil.

Wireless Operation Channel for Different Domains

N. America	2.412-2.462 GHz	Ch01 through CH11
Japan	2.412-2.484 GHz	Ch01 through Ch14
Europe ETSI	2.412-2.472 GHz	Ch01 through Ch13

Regional notice for Singapore

Complies with
IMDA Standards
DB103778

This ASUS product complies with IMDA Standards.

Regional notice for California



WARNING

Cancer and Reproductive Harm -
www.P65Warnings.ca.gov

ENERGY STAR complied product



ENERGY STAR is a joint program of the U.S. Environmental Protection Agency and the U.S. Department of Energy helping us all save money and protect the environment through energy efficient products and practices.

All ASUS products with the ENERGY STAR logo comply with the ENERGY STAR standard, and the power management feature is enabled by default. The monitor and computer are automatically set to sleep after 10 and 30 minutes of user inactivity. To wake your computer, click the mouse or press any key on the keyboard.

Please visit <http://www.energystar.gov/powermanagement> for detail information on power management and its benefits to the environment. In addition, please visit <http://www.energystar.gov> for detail information on the ENERGY STAR joint program.

NOTE: Energy Star is NOT supported on FreeDOS and Linux-based products.

ASUS contact information

ASUSTeK COMPUTER INC.

Address 4F, No. 150, Li-Te Rd., Peitou, Taipei 112, Taiwan
 Telephone +886-2-2894-3447
 Fax +886-2-2890-7798
 Web site <http://www.asus.com>

Technical Support

Telephone +86-21-3842-9911
 Fax +86-21-5866-8722, ext. 9101#
 Online support <http://qr.asus.com/techserv>

ASUS COMPUTER INTERNATIONAL (America)

Address 800 Corporate Way, Fremont, CA 94539, USA
 Telephone +1-510-739-3777
 Fax +1-510-608-4555
 Web site <http://usa.asus.com>

Technical Support

Support fax +1-812-284-0883
 General support +1-812-282-2787
 Online support <http://qr.asus.com/techserv>

ASUS COMPUTER GmbH (Germany and Austria)

Address Harkort Str. 21-23, D-40880 Ratingen, Germany
 Fax +49-2102-959931
 Web site <http://www.asus.com/de>
 Online contact <http://eu-rma.asus.com/sales>

Technical Support

Telephone +49-2102-5789555
 Support Fax +49-2102-959911
 Online support <http://qr.asus.com/techserv>

Manufacturer	ASUSTeK Computer Inc.	
	Tel:	+886-2-2894-3447
	Address:	4F, No. 150, LI-TE RD., PEITOU, TAIPEI 112, TAIWAN
Authorised representative in Europe	ASUSTeK Computer GmbH	
	Address:	HARKORT STR. 21-23, 40880 RATINGEN, GERMANY