

XPS 13 9345

Owner's Manual

Notes, cautions, and warnings

 **NOTE:** A NOTE indicates important information that helps you make better use of your product.

 **CAUTION:** A CAUTION indicates either potential damage to hardware or loss of data and tells you how to avoid the problem.

 **WARNING:** A WARNING indicates a potential for property damage, personal injury, or death.

Chapter 1: Views of XPS 13 9345	6
Right	6
Left	6
Top	7
Active areas of the touchpad	8
Display	9
Bottom	10
Locate the Service Tag or Express Service Code label of your computer	10
Chapter 2: Set up your XPS 13 9345	12
Chapter 3: Specifications of XPS 13 9345	14
Dimensions and weight	14
Processor	14
Chipset	15
Operating system	15
Memory	15
External ports and slots	16
Internal slots	16
Wireless module	17
Audio	17
Storage	18
Keyboard	18
Keyboard shortcuts of XPS 13 9345	19
Camera	20
Touchpad	20
Power adapter	21
Battery	21
Display	22
Fingerprint reader	23
Sensors	23
GPU—Integrated	24
Multiple display support matrix	24
Operating and storage environment	24
Dell low blue light display	25
Chapter 4: Working inside your computer	26
Safety instructions	26
Before working inside your computer	26
Safety precautions	27
Electrostatic discharge—ESD protection	27
ESD Field Service kit	28
Transporting sensitive components	29
After working inside your computer	29

BitLocker.....	29
Recommended tools.....	29
Screw list.....	29
Major components of XPS 13 9345.....	30
Chapter 5: Removing and installing Field Replaceable Units (FRUs).....	33
Base cover.....	33
Removing the base cover.....	33
Installing the base cover.....	37
Battery.....	39
Rechargeable Li-ion battery precautions.....	39
Removing the battery.....	39
Installing the battery.....	43
Solid state drive (SSD).....	46
Removing the M.2 2230 solid state drive.....	46
Installing the M.2 2230 solid state drive.....	48
Removing the M.2 2280 solid state drive.....	50
Installing the M.2 2280 solid state drive.....	52
Fans.....	54
Removing the fans.....	54
Installing the fans.....	55
Heat sink.....	58
Removing the heat sink.....	58
Installing the heat sink.....	58
Display assembly.....	59
Removing the display assembly.....	59
Installing the display assembly.....	62
System board.....	64
Removing the system board.....	64
Installing the system board.....	67
Power button with fingerprint reader.....	71
Removing the power button with fingerprint reader.....	71
Installing the power button with a fingerprint reader.....	73
Keyboard.....	74
Removing the keyboard.....	74
Installing the keyboard.....	77
Palm-rest assembly.....	81
Removing the palm-rest assembly.....	81
Installing the palm-rest assembly.....	82
Chapter 6: Software.....	84
Operating system.....	84
Drivers and downloads.....	84
Chapter 7: BIOS Setup.....	85
Entering BIOS Setup program.....	85
Navigation keys.....	85
F12 One Time Boot menu.....	85
View Advanced Setup options.....	86

System Setup options.....	86
Updating the BIOS.....	97
Updating the BIOS in Windows.....	97
Updating the BIOS using the USB drive in Windows.....	98
Updating the BIOS from the One-Time boot menu.....	98
System and setup password.....	98
Assigning a System Setup password.....	99
Deleting or changing an existing system password or setup password.....	99
Clearing system and setup passwords.....	99
Clearing chassis intrusion alert.....	100
Chapter 8: Troubleshooting.....	102
Handling swollen rechargeable Li-ion batteries.....	102
Locating the Service Tag or Express Service Code of your Dell computer	102
Dell SupportAssist Pre-boot System Performance Check diagnostics.....	103
Running the SupportAssist Pre-Boot System Performance Check.....	103
Built-in self-test (BIST).....	103
LCD Built-in Self-Test (LCD-BIST).....	103
LCD Power rail test (L-BIST).....	104
System-diagnostic lights.....	104
Backup media and recovery options.....	104
Network power cycle.....	104
Drain flea power (perform hard reset).....	105
Chapter 9: Getting help and contacting Dell.....	106

Views of XPS 13 9345

Right



Figure 1. Right view

1. USB4 40 Gbps USB Type-C port with DisplayPort and Power Delivery

Connect devices such as external storage devices, printers, and external displays. Provides a data transfer rate of up to 40 Gbps. Supports Power Delivery that enables two-way power supply between devices. Supports DisplayPort 1.4a that enables you to connect to an external display using a display adapter.

NOTE: You can connect a Dell docking station to one of the two USB Type-C ports. If your docking station has two cables, do not connect both cables to the two USB Type-C ports simultaneously. You may encounter issues with the charging circuits when this method of connection is used. For more information, search in the Knowledge Base Resource at the [Dell Support site](#).

NOTE: A 40 Gbps-certified cable is required to achieve the maximum performance of 40 Gbps.

NOTE: A USB Type-C to DisplayPort adapter (sold separately) is required to connect to a DisplayPort device.

NOTE: The USB4 Type-C port is backward compatible with USB 3.2 and USB 2.0.

Left



Figure 2. Left view

1. USB4 40 Gbps USB Type-C port with DisplayPort and Power Delivery

Connect devices such as external storage devices, printers, and external displays. Provides a data transfer rate of up to 40 Gbps. Supports Power Delivery that enables two-way power supply between devices. Supports DisplayPort 1.4a that enables you to connect to an external display using a display adapter.

NOTE: You can connect a Dell docking station to one of the two USB Type-C ports. If your docking station has two cables, do not connect both cables to the two USB Type-C ports simultaneously. You may encounter issues with the

charging circuits when this method of connection is used. For more information, search in the Knowledge Base Resource at the [Dell Support site](#).

NOTE: A 40 Gbps-certified cable is required to achieve the maximum performance of 40 Gbps.

NOTE: A USB Type-C to DisplayPort adapter (sold separately) is required to connect to a DisplayPort device.

NOTE: The USB4 Type-C port is backward compatible with USB 3.2 and USB 2.0.

Top



Figure 3. Top view

1. Microphones (2)

Provide digital sound input for audio recording, voice calls, and so on.

2. Capacitive touch function row

Displays media and display control keys or standard function keys, with **esc** and **delete** keys.

Press and hold the **fn** key on the physical keyboard to switch to the next set of keys.

Press the **fn** key on the physical keyboard and the **esc** key on the capacitive touch function row to switch to the next set of keys and lock the mode of the panel.

3. Power button with fingerprint reader

Press to turn on the computer if it is turned off, in sleep state, or in hibernate state.

When the computer is turned on, press the power button to put the computer into a sleep state; press and hold the power button for 10 seconds to force shut-down the computer.

If the power button has a fingerprint reader, place your finger on the power button steadily to log in.

NOTE: You can customize the power-button behavior in Windows.

4. Touchpad

Move your finger on the touchpad to control the cursor. For more information about the active areas of the touchpad, see the section on [Active areas of the touchpad controls](#).

5. Service LED

The service LED is used for troubleshooting with a Dell service representative. The LED emits amber or white light.

Active areas of the touchpad



Figure 4. Active areas of the touchpad

1. Left-click area of the touchpad

Move your finger on the touchpad within this area to control the cursor. Tap this area to left-click.

2. Right-click area of the touchpad

Move your finger on the touchpad within this area to control the cursor. Tap this area to right-click.

Display



Figure 5. Display view

- 1. Infrared emitter**
Emits infrared light, which enables the infrared camera to sense and track motion.
- 2. Infrared camera**
Enhances security when paired with Windows Hello face authentication.
- 3. RGB and infrared camera**
Enables you to video chat, capture photos, and record videos in RGB and infrared.
- 4. Camera-status light**
Turns on when the camera is in use.
- 5. Ambient-light sensor**
The sensor detects the ambient light and automatically adjusts the keyboard backlight and display brightness.
- 6. Infrared emitter**
Emits infrared light, which enables the infrared camera to sense and track motion.

Bottom



Figure 6. Bottom view

1. Left speaker

Provides audio output.

2. MyDell QR code

MyDell is your hub for content that is personalized to your XPS 13 9345, including videos, articles, manuals, and access to support."

3. Service Tag/Express Service Code label

The Service Tag is a unique alphanumeric identifier that enables Dell service technicians to identify the hardware components in your computer and access warranty information. The Express Service Code is a numeric version of the Service Tag.

4. Right speaker

Provides audio output.

Locate the Service Tag or Express Service Code label of your computer

The service tag is a unique alphanumeric identifier that allows Dell service technicians to identify the hardware components in your computer and access warranty information. The Express Service Code is a numeric version of the Service Tag.

For more information about how to find the Service Tag of your computer, search in the Knowledge Base Resource at the [Dell Support Site](#).



Figure 7. Service Tag/Express Service Code location

Set up your XPS 13 9345

About this task

NOTE: The images in this document may differ from your computer depending on the configuration you ordered.

Steps

1. Connect the power adapter and press the power button.



Figure 8. Connect the power adapter and press the power button.

NOTE: The battery may enter power-saving mode during shipment to conserve charge on the battery. Ensure that the power adapter is connected to your computer when it is turned on for the first time.

2. Finish the operating system setup.

For Windows:

Follow the on-screen instructions to complete the setup. When setting up, Dell Technologies recommends that you:





- Connect to a network for Windows updates.

NOTE: If connecting to a secured wireless network, enter the password for the wireless network access when prompted.

- If connected to the Internet, sign in with or create a Microsoft account.
- On the **Support and Protection** screen, enter your contact details.

3. Locate and use Dell apps from the Windows Start menu—Recommended.

Table 1. Locate Dell apps in Windows

Resources	Description
	<p>My Dell</p> <p>MyDell is a software application that offers you a single streamlined engagement platform including account access, device information, and hardware settings. This software delivers intelligent features that automatically fine-tune your computer for the best possible audio, power, and performance. Get the most out of your Dell device with intelligent, personalized technology from MyDell. Following are the key features of MyDell:</p> <ul style="list-style-type: none"> ● Application ● Audio ● Power ● Color and Display ● Presence detection <p>For more information about how to use MyDell, see product guides at the Dell Support Site.</p>
	<p>Dell Update</p> <p>Updates your computer with critical fixes and latest device drivers as they become available. For more information about using Dell Update, see the product guides and third-party license documents at the Dell Support Site.</p>
	<p>Dell Digital Delivery</p> <p>Download software applications, which are purchased but not preinstalled on your computer. For more information about using Dell Digital Delivery, search in the Knowledge Base Resource at the Dell Support Site.</p>
	<p>SupportAssist</p> <p>SupportAssist proactively and predictively identifies hardware and software issues on your computer and automates the engagement process with Dell Technical support. It addresses performance and stabilization issues, prevents security threats, monitors, and detects hardware failures. For more information, see <i>SupportAssist for Home PCs User's Guide</i> at the Dell SupportAssist site.</p> <p>NOTE: In SupportAssist, click the warranty expiry date to renew or upgrade your warranty.</p>

Specifications of XPS 13 9345

Dimensions and weight

The following table lists the height, width, depth, and weight of your XPS 13 9345.

Table 2. Dimensions and weight

Description	Values
Height	<ul style="list-style-type: none"> 15.25 mm (0.60 in.) with OLED display 15.95 mm (0.63 in.) with QHD+ or FHD+ display
Width	295.30 mm (11.63 in.)
Depth	199.06 mm (7.84 in.)
Minimum weight <i>i</i> NOTE: The weight of your computer depends on the configuration that is ordered and manufacturing variability.	Starting weight: <ul style="list-style-type: none"> 1.23 kg (2.67 lb) with OLED display 1.24 kg (2.73 lb) with QHD+ display 1.24 kg (2.72 lb) with FHD+ display

Processor

The following table lists the details of the processors that are supported in your XPS 13 9345.

Table 3. Processor

Description	Option one	Option two	Option three
Processor type	Qualcomm Snapdragon X Elite X1E-80-100	Qualcomm Snapdragon X Plus X1P-64-100	Qualcomm Snapdragon X Plus X1P-42-100
Processor wattage	18 W	18 W	18 W
Processor core count	12	10	8
Processor thread count	12	10	8
Processor speed	Up to 4 GHz	Up to 3.4 GHz	Up to 3.4 GHz
Processor cache	42 MB	42 MB	30 MB
Integrated graphics	Qualcomm Adreno GPU	Qualcomm Adreno GPU	Qualcomm Adreno GPU
Neural Processing Unit (NPU)	Up to 45 TOPS	Up to 45 TOPS	Up to 45 TOPS

Chipset

The following table lists the details of the chipset that is supported by your XPS 13 9345.

Table 4. Chipset

Description	Values
Chipset	Integrated in the processor
Processor	Qualcomm Snapdragon X Elite/Qualcomm Snapdragon X Plus
DRAM bus width	Eight channel, 16-bit LPDDR5X SDRAM
Flash EPROM	42 MB
PCIe bus	Up to Gen4

Operating system

Your XPS 13 9345 supports the following operating systems:

- Windows 11 Home, ARM
- Windows 11 Pro, ARM

Memory

The following table lists the memory specifications of your XPS 13 9345.

Table 5. Memory specifications

Description	Values
Memory slots	No memory slots  NOTE: The memory is integrated on the system board and is not upgradeable.
Memory type	LPDDR5X
Memory speed	8448 MT/s
Maximum memory configuration	64 GB
Minimum memory configuration	16 GB
Memory configurations supported	<ul style="list-style-type: none">• 16 GB: LPDDR5X, 8448 MT/s, integrated, dual-channel• 32 GB: LPDDR5X, 8448 MT/s, integrated, dual-channel• 64 GB: LPDDR5X, 8448 MT/s, integrated, dual-channel

External ports and slots

The following table lists the external ports and slots on your XPS 13 9345.

Table 6. External ports and slots

Description	Values
USB ports	Two USB4 40 Gbps USB Type-C ports with DisplayPort and Power Delivery i NOTE: You can connect a Dell docking station to one of the two USB Type-C ports. If your docking station has two cables, do not connect both cables to the two USB Type-C ports simultaneously. You may encounter issues with the charging circuits when this method of connection is used. For more information, search in the Knowledge Base Resource at the Dell Support site .
Audio port	Supported through the USB4 40 Gbps USB Type-C ports with DisplayPort and Power Delivery i NOTE: A USB-C to 3.5 mm AUX audio adapter can be purchased separately to connect an audio device.
Video port(s)	Supported through the USB4 40 Gbps USB Type-C ports with DisplayPort and Power Delivery i NOTE: A USB-C to DisplayPort adapter can be purchased separately to connect a DisplayPort device.
Media-card reader	Not supported
Power-adaptor port	Supported through the USB4 40 Gbps USB Type-C ports with DisplayPort and Power Delivery i NOTE: You can connect a Dell docking station to one of the two USB Type-C ports. If your docking station has two cables, do not connect both cables to the two USB Type-C ports simultaneously. You may encounter issues with the charging circuits when this method of connection is used. For more information, search in the Knowledge Base Resource at the Dell Support site .
Security-cable slot	Not supported

Internal slots

The following table lists the internal slots of your XPS 13 9345.

Table 7. Internal slots

Description	Values
M.2	One M.2 slot for M.2 2230 or M.2 2280 solid-state drive i NOTE: To learn more about the features of different types of M.2 cards, search in the Knowledge Base Resource at Dell Support Site .

Wireless module

The following table lists the Wireless Local Area Network (WLAN) module that is supported on your XPS 13 9345.

Table 8. Wireless module specifications

Description	Values
Model number	Qualcomm FastConnect 7800 DBS (onboard)
Transfer rate	Up to 5760 Mbps
Frequency bands supported	2.4 GHz/5 GHz/6 GHz
Wireless standards	<ul style="list-style-type: none"> • WiFi 802.11a/b/g • Wi-Fi 4 (WiFi 802.11n) • Wi-Fi 5 (WiFi 802.11ac) • Wi-Fi 6E (WiFi 802.11ax) • Wi-Fi 7 (WiFi 802.11be)
Encryption	<ul style="list-style-type: none"> • 64-bit/128-bit WEP • AES-CCMP • TKIP
Bluetooth wireless card  NOTE: The functionality of the Bluetooth wireless card may vary based on the operating system.	Bluetooth 5.4

Audio

The following table lists the audio specifications of your XPS 13 9345.

Table 9. Audio specifications

Description	Values
Audio controller	Qualcomm Hexagon Audio DSP
Stereo conversion	Supported
Internal audio interface	SoundWire interface
External audio interface	Supported through the USB4 40 Gbps USB Type-C ports with DisplayPort and Power Delivery  NOTE: A USB-C to 3.5 mm AUX audio adapter can be purchased separately to connect an audio device.
Number of speakers	<ul style="list-style-type: none"> • Two tweeter speakers • Two woofer speakers
Internal-speaker amplifier	Qualcomm Aqstic smart speaker amplifier (WSA8845)
External volume controls	Keyboard shortcut controls
Speaker output:	
	Average
	<ul style="list-style-type: none"> • 2 W + 2 W (tweeter) • 2 W + 2 W (woofer)

Table 9. Audio specifications (continued)

Description		Values
	Peak	<ul style="list-style-type: none"> 2.5 W + 2.5 W (tweeter) 2.5 W + 2.5 W (woofer)
Microphone		Dual-array microphones

Storage

This section lists the storage options on your XPS 13 9345.

Your XPS 13 9345 supports one M.2 2230 or M.2 2280 solid-state drive.

Table 10. Storage specifications

Storage type	Interface type	Capacity
M.2 2230 solid-state drive	Gen4 x4 PCIe NVMe	256 GB
M.2 2230 solid-state drive	Gen4 PCIe NVMe	512 GB
M.2 2280 solid-state drive	Gen4 PCIe NVMe	1 TB
M.2 2280 solid-state drive	Gen4 PCIe NVMe	2 TB

Keyboard

The following table lists the keyboard specifications of your XPS 13 9345.

Table 11. Keyboard specifications





Description	Values
Keyboard type	Backlit keyboard with Copilot key  NOTE: The top row of the keyboard is a capacitive touch function row, which displays standard function keys or media and display control keys.
Keyboard layout	QWERTY
Number of keys	<ul style="list-style-type: none"> English US, English International, Canada (Bilingual), Arabic, Hebrew, Korean: 64 keys English UK, French, German, Nordic, Czech and Slovakian, Hungarian, Italian, Portuguese Iberian, Spanish Castillian, Spanish Latin America, Swiss, Turkish: 65 keys Japanese: 68 keys
Keyboard size	X=19.05 mm key pitch Y=18.05 mm key pitch
Keyboard shortcuts	Some keys on your keyboard have two symbols on them. These keys can be used to type alternate characters or to perform secondary functions. To type the alternate character, press Shift and the desired key. To perform secondary functions, press fn and the desired key.

Table 11. Keyboard specifications (continued)

Description	Values
	<p> NOTE: You can define the primary behavior of the function keys (F1–F12) changing Fn Lock Options in the BIOS setup program.</p> <p> NOTE: If Copilot in Windows is not available on your computer, the Copilot key launches Recall. If both Recall and Copilot in Windows are not available on your computer, the Copilot key launches Windows Search. For more information about Copilot in Windows and Recall, search in the Knowledge Base Resource at the Dell Support Site.</p>

Keyboard shortcuts of XPS 13 9345

 **NOTE:** Keyboard characters may differ depending on the keyboard language configuration. Keys that are used for shortcuts remain the same across all language configurations.

Some keys on your keyboard have two symbols on them. These keys can be used to type alternate characters or to perform secondary functions. The symbol that is shown on the lower part of the key refers to the character that is typed out when the key is pressed. If you press **shift** and the key, the symbol that is shown on the upper part of the key is typed out. For example, if you press **2**, **2** is typed out; if you press **Shift + 2**, **@** is typed out.

The top row of the keyboard is a capacitive touch function row. The **fn** mechanical key toggles between the keys **F1-F12** and keys for multimedia control. Releasing the **fn** key switches back to the previous mode.

Pressing the **fn** key and the **esc** key locks the "mode" of the capacitive touch function row. If the computer restarts, the default mode is the last mode set by the user before the computer is restarted.

The **fn** key is also used with selected keys on the keyboard to invoke other secondary functions.

Table 12. List of keyboard shortcuts

Keyboard shortcut	Behavior
fn	Switch between modes of the capacitive touch function row
fn + B	Pause
fn + S	Toggle scroll lock
fn + R	System request
fn + ctrl + B	Break
fn + esc	Lock the mode of the capacitive touch function row
fn + left arrow	Home
fn + right arrow	End
Copilot	<p>Launch Copilot in Windows</p> <p> NOTE: If Copilot in Windows is not available on your computer, the Copilot key launches Recall. If both Recall and Copilot in Windows are not available on your computer, the Copilot key launches Windows Search. For more information about Copilot in Windows and Recall, search in the Knowledge Base Resource at the Dell Support Site.</p>

Camera

The following table lists the camera specifications of your XPS 13 9345.

Table 13. Camera specifications

Description		Values
Number of cameras		Two
Camera type		<ul style="list-style-type: none">• FHD RGB camera• IR camera
Camera location		Front
Camera sensor type		CMOS sensor technology
Camera resolution:		
	Still image	2.07 megapixel
	Video	1920 x 1080 (FHD) at 30 fps
Infrared camera resolution:		
	Video	640 x 360 at 15 fps
Diagonal viewing angle:		
	Camera	81.30 degrees
	Infrared camera	78.10 degrees

Touchpad

The following table lists the touchpad specifications of your XPS 13 9345.

Table 14. Touchpad specifications

Description		Values
Touchpad resolution:		
	Horizontal	1300
	Vertical	722
Touchpad dimensions:		
	Horizontal	112.30 mm (4.42 in.)
	Vertical	64.15 mm (2.53 in.)
Touchpad gestures		For more information about the touchpad gestures available on Windows, see the Microsoft Knowledge Base article at Microsoft Support Site .

Power adapter

The following table lists the power adapter specifications of your XPS 13 9345.

Table 15. Power-adapter specifications

Description		Values
Type		60W AC adapter, USB Type-C
Power-adapter dimensions:		
	Height	22 mm (0.87 in.)
	Width	55 mm (2.17 in.)
	Depth	66 mm (2.60 in.)
Input voltage		100 VAC–240 VAC
Input frequency		50 Hz–60 Hz
Input current (maximum)		1.70 A
Output current (continuous)		3 A
Rated output voltage		<ul style="list-style-type: none"> • 20 VDC • 15 VDC • 9 VDC • 5 VDC
Temperature range:		
	Operating	0°C to 40°C (32°F to 104°F)
	Storage	-20°C to 70°C (-4°F to 158°F)
 CAUTION: Operating and storage temperature ranges may differ among components, so operating or storing the device outside these ranges may impact the performance of specific components.		



Battery

The following table lists the battery specifications of your XPS 13 9345.

Table 16. Battery specifications

Description		Values
Battery type		3-cell, 55 Wh "smart" lithium-ion
Battery voltage		11.55 VDC
Battery weight (maximum)		0.219 kg (0.483 lb)
Battery dimensions:		
	Height	238.40 mm (9.39 in.)
	Width	4.86 mm (0.19 in.)
	Depth	97.41 mm (3.84 in.)

Table 16. Battery specifications (continued)

Description	Values
Temperature range:	
Operating	0°C to 65°C (32°F to 149°F)
Storage	-20°C to 65°C (-4°F to 149°F)
Battery operating time	Varies depending on operating conditions and can significantly reduce under certain power-intensive conditions
Battery charging time (approximate)  NOTE: You can control the charging time, duration, start and end time, and so on, using the settings on the MyDell (replaced with Dell Optimizer) application (Power option). For more information about MyDell (replaced with Dell Optimizer) application, search in the Knowledge Base Resource at Dell Support Site .	3 hours (when the computer is off)
Coin-cell battery	Not applicable
 CAUTION: Operating and storage temperature ranges may differ among components, so operating or storing the device outside these ranges may impact the performance of specific components.	
 CAUTION: Dell Technologies recommends that you charge the battery regularly for optimal power consumption.	

Display

The following table lists the display specifications of your XPS 13 9345.

Table 17. Display specifications

Description	Option one	Option two	Option three
Display type	Quad High Definition (QHD+), Eyesafe, low blue light	Full High Definition (FHD+), Eyesafe, low blue light	3K, OLED, Eyesafe low blue light display technology
Touch options	Yes	No	Yes
Display-panel technology	Wide Viewing Angle (WVA)	Wide Viewing Angle (WVA)	Wide Viewing Angle (WVA)
Display-panel dimensions (active area):			
Height	288 mm (11.34 in.)	288 mm (11.34 in.)	288 mm (11.34 in.)
Width	180 mm (7.09 in.)	180 mm (7.09 in.)	180 mm (7.09 in.)
Diagonal	339.60 mm (13.37 in.)	339.60 mm (13.37 in.)	339.60 mm (13.37 in.)
Display-panel native resolution	2560 x 1600	1920 x 1200	2880 x 1800
Luminance (typical)	500 nits	500 nits	400 nits
Megapixels	4.096	2.304	5.184
Color gamut	<ul style="list-style-type: none"> DCI-P3 100% typical 95% minimum 	<ul style="list-style-type: none"> sRGB 100% typical 95% minimum 	<ul style="list-style-type: none"> DCI-P3 100% typical 95% minimum

Table 17. Display specifications (continued)

Description	Option one	Option two	Option three
Pixels Per Inch (PPI)	225.7	169.3	254
Contrast ratio (typical)	2000:1	2000:1	1000000:1
Response time (maximum)	35 ms	35 ms	2 ms
Refresh rate	120 Hz (maximum)	120 Hz (maximum)	60 Hz (maximum)
Horizontal view angle	85 degrees	85 degrees	85 degrees
Vertical view angle	85 degrees	85 degrees	85 degrees
Pixel pitch	0.1125 mm	0.150 mm	0.10002 mm
Power consumption (maximum)	3.91 W	2.2 W	6.07 W
Anti-glare vs glossy finish	Anti-reflective, Anti-smudge	Anti-glare	Anti-reflective, Anti-smudge

Fingerprint reader

The following table lists the fingerprint-reader specifications of your XPS 13 9345.

 **NOTE:** The fingerprint reader is on the power button.

Table 18. Fingerprint reader specifications

Description	Values
Sensor technology	Trans-capacitive sensing
Sensor resolution	500 dpi
Sensor pixel size	88 x 108

Sensors

The following table lists the sensors of your XPS 13 9345.

Table 19. Sensor

Sensor support
Ambient Light Sensor
Adaptive Thermal Performance
Wake/Power on with lid open
Hall sensor

GPU—Integrated

The following table lists the specifications of the integrated Graphics Processing Unit (GPU) supported by your XPS 13 9345.

Table 20. GPU—Integrated

Controller	Memory size	Processor
Qualcomm Adreno GPU	Shared system memory	<ul style="list-style-type: none"> Qualcomm Snapdragon X Elite X1E-80-100 (3.8 TFLOPS) Qualcomm Snapdragon X Plus X1P-64-100 (3.8 TFLOPS) Qualcomm Snapdragon X Plus X1P-42-100 (1.7 TFLOPS)

Multiple display support matrix

The following table lists the multi-monitor support matrix that is supported by your XPS 13 9345.

Table 21. Integrated - Multiple display support matrix

Description	Values
Video ports on Integrated Graphics Card	Two USB4 40 Gbps USB Type-C ports with DisplayPort and Power Delivery
Number of displays	Up to three 4K external displays using the USB4 Type-C ports

 **NOTE:** For more information about connecting external displays to your computer, see the *External Display Connection Guide* for this computer at the [Dell Support Site](#).

Operating and storage environment

This table lists the operating and storage specifications of your XPS 13 9345.

Airborne contaminant level: G1 as defined by ISA-S71.04-1985

Table 22. Computer environment

Description	Operating	Storage
Temperature range	0°C to 35°C (32°F to 95°F)	-30°C to 65°C (-22°F to 149°F)
Relative humidity (maximum)	10% to 90% (non-condensing)	0% to 95% (non-condensing)
Vibration (maximum)*	0.66 GRMS	1.30 GRMS
Shock (maximum)	110 G†	160 G†
Altitude range	-15.2 m to 3048 m (-49.87 ft to 10,000 ft)	-15.2 m to 10668 m (-49.87 ft to 35,000 ft)

 **CAUTION:** Operating and storage temperature ranges may differ among components, so operating or storing the device outside these ranges may impact the performance of specific components.

* Measured using a random vibration spectrum that simulates user environment.

† Measured using a 2 ms half-sine pulse when the hard drive is in use.

Dell low blue light display

 **WARNING: Prolonged exposure to blue light from the display may lead to long-term effects such as eye strain, eye fatigue, or damage to the eyes.**

Blue light is a color in the light spectrum which has a short wavelength and high energy. Chronic exposure to blue light, particularly from digital sources may disrupt sleep patterns and cause long-term effects such as eye strain, eye fatigue, or damage to the eyes.

The display on this computer is designed to minimize blue light and complies with TÜV Rheinland's requirement for low blue light (hardware solution) displays.

Low blue light (hardware solution) mode is enabled at the factory, so no further configuration is necessary.











To reduce the risk of eye strain, it is also recommended that you:

- Position the display at a comfortable viewing distance between 20 and 28 inches (50 cm and 70 cm) from your eyes.
- Blink frequently to moisten your eyes, wet your eyes with water, or apply suitable eye drops.
- Look away from your display, and gaze at a distant object at 20 ft (609.60 cm) away for at least 20 seconds during each break.
- Take an extended break for 20 minutes every two hours.

Working inside your computer

Safety instructions

Use the following safety guidelines to protect your computer from potential damage and to ensure your personal safety. Unless otherwise noted, each procedure in this document assumes that you have read the safety information that shipped with your computer.

-  **WARNING:** Before working inside your computer, read the safety information that is shipped with your computer. For more safety best practices, see [Dell Regulatory Compliance Home Page](#).
-  **WARNING:** Disconnect your computer from all power sources before opening the computer cover or panels. After you finish working inside the computer, replace all covers, panels, and screws before connecting your computer to an electrical outlet.
-  **WARNING:** For laptop computers, discharge the battery completely before removing it. Disconnect the AC power adapter from the computer and operate the computer solely on battery power—the battery is fully discharged when the computer no longer turns on when the power button is pressed.
-  **CAUTION:** To avoid damaging the computer, ensure that the work surface is flat, dry, and clean.
-  **CAUTION:** You should only perform troubleshooting and repairs as authorized or directed by the Dell technical support team. Damage due to servicing that is not authorized by Dell is not covered by your warranty.
-  **CAUTION:** Before touching anything inside your computer, ground yourself by touching an unpainted metal surface, such as the metal at the back of the computer. While you work, periodically touch an unpainted metal surface to dissipate static electricity which could harm internal components.
-  **CAUTION:** To avoid damaging the components and cards, handle them by their edges, and avoid touching the pins and the contacts.
-  **CAUTION:** When you disconnect a cable, pull it by its connector or its pull tab, not the cable itself. Some cables have connectors with locking tabs or thumbscrews that you must disengage before disconnecting the cable. When disconnecting cables, keep them evenly aligned to avoid bending the connector pins. When connecting cables, ensure that the connector on the cable is correctly oriented and aligned with the port.
-  **CAUTION:** Press and eject any installed card from the media-card reader.
-  **CAUTION:** Exercise caution when handling rechargeable Li-ion batteries in laptops. Swollen batteries should not be used and should be replaced and disposed properly.

Before working inside your computer

About this task

 **NOTE:** The images in this document may differ from your computer depending on the configuration you ordered.

Steps

1. Save and close all open files and exit all open applications.
2. Shut down your computer. For Windows operating system, click **Start** >  **Power** > **Shut down**.

 **NOTE:** If you are using a different operating system, see the documentation of your operating system for shut-down instructions.

3. Turn off all the attached peripherals.
4. Disconnect your computer and all attached devices from their electrical outlet.
5. Disconnect all attached network devices and peripherals, such as keyboard, mouse, and monitor from your computer.

 **CAUTION:** To disconnect a network cable, unplug the cable from your computer.

6. Remove any media card and optical disc from your computer, if applicable.

Safety precautions

This section details the primary steps to be followed before disassembling any device or component.

Observe the following safety precautions before any installation or break-fix procedures involving disassembly or reassembly:

- Turn off the computer and all attached peripherals.
- Disconnect the computer from AC power.
- Disconnect all network cables and peripherals from the computer.
- Use an ESD field service kit when working inside your computer to avoid electrostatic discharge (ESD) damage.
- Place the removed component on an anti-static mat after removing it from the computer.
- Press and hold the power button for 15 seconds to discharge the residual power in the system board.

Bonding

Bonding is a method for connecting two or more grounding conductors to the same electrical potential. This is done by using a field service electrostatic discharge (ESD) kit. When connecting a bonding wire, ensure that it is connected to bare metal and never to a painted or nonmetal surface. Ensure that the wrist strap is secure and in full contact with your skin. Remove all jewelry, watches, bracelets, or rings before grounding yourself and the equipment.

Electrostatic discharge—ESD protection

ESD is a major concern when you handle electronic components, especially sensitive components such as expansion cards, processors, memory modules, and system boards. A slight charge can damage circuits in ways that may not be obvious, such as intermittent problems or a shortened product life span. As the industry pushes for lower power requirements and increased density, ESD protection is an increasing concern.

Two recognized types of ESD damage are catastrophic and intermittent failures.

- **Catastrophic** – Catastrophic failures represent approximately 20 percent of ESD-related failures. The damage causes an immediate and complete loss of device functionality. An example of catastrophic failure is a memory module that has received a static shock and immediately generates a "No POST/No Video" symptom with a beep code that is emitted for missing or nonfunctional memory.
- **Intermittent** – Intermittent failures represent approximately 80 percent of ESD-related failures. The high rate of intermittent failures means that most of the time when damage occurs, it is not immediately recognizable. The memory module receives a static shock, but the tracing is merely weakened and does not immediately produce outward symptoms that are related to the damage. The weakened trace may take weeks or months to melt, and in the meantime may cause degradation of memory integrity, intermittent memory errors, and so on.

Intermittent failures that are also called latent or "walking wounded" are difficult to detect and troubleshoot.

Perform the following steps to prevent ESD damage:

- Use a wired ESD wrist strap that is properly grounded. Wireless anti-static straps do not provide adequate protection. Touching the chassis before handling parts does not ensure adequate ESD protection on parts with increased sensitivity to ESD damage.
- Handle all static-sensitive components in a static-safe area. If possible, use anti-static floor pads and workbench pads.
- When unpacking a static-sensitive component from its shipping carton, do not remove the component from the anti-static packing material until you are ready to install the component. Before unwrapping the anti-static packaging, use the anti-static wrist strap to discharge the static electricity from your body.

NOTE: You can protect against ESD and discharge static electricity from your body by touching a metal-grounded object before you interact with anything electronic, for example, an unpainted metal surface on your computer's I/O panel. When connecting a peripheral (including handheld digital assistants) to your computer, you should always ground both yourself and the peripheral before connecting it to the computer. In addition, as you work inside the computer, periodically touch a metal-grounded object to remove any static charge that your body may have accumulated.

For more information about the wrist strap and ESD wrist strap tester, see [Components of an ESD Field Service Kit](#).

- Before transporting a static-sensitive component, place it in an anti-static container or packaging.

ESD Field Service kit

The unmonitored field service kit is the most commonly used service kit. Each Field Service kit includes three main components: anti-static mat, wrist strap, and bonding wire.

CAUTION: It is critical to keep ESD-sensitive devices away from internal parts that are insulated and often highly charged, such as plastic heat sink casings.

Working environment

Before the ESD Field Service kit is deployed, conduct an evaluation of the site to ensure proper setup and readiness. For example, deploying the kit for a server environment is different than for a desktop or laptop environment. Servers are typically installed in a rack within a data center; desktops or laptops are typically placed on office desks or cubicles. Always look for a large open flat work area that is free of clutter and large enough to deploy the ESD kit with additional space to accommodate the type of computer that is being repaired. The workspace should also be free of insulators that can cause an ESD event. On the work area, insulators such as styrofoam and other plastics should always be moved at least 12 inches or 30 centimeters away from sensitive parts before physically handling any hardware components.

ESD packaging

All ESD-sensitive devices must be shipped and received in static-safe packaging. Metal, static-shielded bags are preferred. However, you should always return the damaged component using the same ESD bag and packaging that the new part arrived in. The ESD bag should be folded over and taped shut and all the same foam packing material should be used in the original box that the new part arrived in. ESD-sensitive devices should be removed from packaging only at an ESD-protected work surface, and parts should never be placed on top of the ESD bag because only the inside of the bag is shielded. Always place parts in your hand, on the anti-static mat, in the computer, or inside an ESD bag.

Components of an ESD Field Service kit

The components of an ESD Field Service kit are:

- **Anti-Static Mat** – The anti-static mat is dissipative and parts can be placed on it during service procedures. When using an anti-static mat, your wrist strap should be snug and the bonding wire should be connected to the anti-static mat and to any bare metal on the computer being worked on. Once deployed properly, service parts can be removed from the ESD bag and placed directly on the anti-static mat. ESD-sensitive items are safe in your hand, on the anti-static mat, in the computer, or inside an ESD bag.
- **Wrist Strap and Bonding Wire** – If an anti-static mat is not being used, the wrist strap and bonding wire should be connected directly between your wrist and an exposed metal part of the hardware. If you are using an anti-static mat, connect the wrist strap and bonding wire to the anti-static mat to ensure protection for any hardware placed on the mat. The physical connection of the wrist strap and bonding wire between your skin, the anti-static mat, and the hardware is known as bonding. Use only Field Service kits with a wrist strap, anti-static mat, and bonding wire. Never use wireless wrist straps. Always be cautious that the internal wires of a wrist strap are prone to damage from normal wear and tear, and must be checked regularly with a wrist strap tester in order to avoid accidental ESD hardware damage. It is recommended to test the wrist strap and bonding wire at least once per week.
- **ESD Wrist Strap Tester** – The wires inside an ESD strap are prone to damage over time. When using an unmonitored ESD kit, it is recommended to test the wrist strap regularly—ideally before each service session, and at a minimum, once per week. The most reliable method for testing is with a wrist strap tester. To perform the test, connect the bonding wire of the wrist strap to the tester while wearing the strap. Press the test button to initiate the check. A green LED indicates a successful test, while a red LED and audible alarm signal a failure.

NOTE: It is recommended to always use the traditional wired ESD grounding wrist strap and protective anti-static mat when servicing Dell products. In addition, it is critical to keep sensitive parts separate from all insulator parts while servicing the computer.

Transporting sensitive components

When transporting ESD sensitive components such as replacement parts or parts to be returned to Dell, it is critical to place these parts in anti-static bags for safe transport.

After working inside your computer

About this task

CAUTION: Leaving stray or loose screws inside your computer may severely damage your computer.

Steps

1. Replace all screws and ensure that no stray screws remain inside your computer.
2. Connect any external devices, peripherals, or cables you removed before working on your computer.
3. Replace any media cards, discs, or any other components that you removed before working on your computer.
4. Connect your computer and all attached devices to their electrical outlets.
5. Turn on your computer.

BitLocker

When updating the BIOS on a computer with BitLocker enabled, consider the following precautions.

CAUTION: If BitLocker is not suspended before updating the BIOS, the BitLocker key will not be recognized the next time that you reboot the computer. You are prompted to enter the recovery key to progress, and the computer displays a prompt for the recovery key on each reboot. If the recovery key is not known, this can result in data loss or an operating system reinstall. For more information, see Knowledge Article: [updating the BIOS on Dell computers with BitLocker enabled](#).

The installation of the following components triggers BitLocker:

- Hard disk drive or solid state drive
- System board

Recommended tools

The procedures in this document may require the following tools:

- Phillips screwdriver #0
- Torx #5 (T5) screwdriver

Screw list

NOTE: When removing screws from a component, it is recommended to note the screw type and the quantity of screws, and then place them in a screw storage box. This is to ensure that the correct number of screws and correct screw type is restored when the component is replaced.

NOTE: Some computers have magnetic surfaces. Ensure that the screws are not left attached to such surfaces when replacing a component.

NOTE: Screw color may vary depending on the configuration ordered.

Table 23. Screw list

Component	Screw type	Quantity	Screw image
Base cover	M2x3, T5	6	
Battery	M1.6x2.5	6	
Battery-connector bracket	M1.6x2, captive	1	
Solid state drive shield	M2x3	1	
Fans	M1.6x2.5	4 i NOTE: 2 screws each for left and right fans.	
Heat sink	M1.4x2, captive	4	
Display-assembly cable bracket	M1.6x2, captive	3	
Display-assembly cable holder	M1.6x2.5	3	
Display-assembly hinges	M2.5x5	6 i NOTE: Includes 2 screws each for left and right hinges.	
Wireless-card bracket	M1.6x2.3, captive	1	
Type-C bracket	M1.6x3	4	
System board	M1.6x2.3	7	
Power button with fingerprint reader	M1.4x2	4	
Keyboard	M1.4x1.2	17	
Keyboard	M1.6x2	7	

Major components of XPS 13 9345

The following image shows the major components of XPS 13 9345.

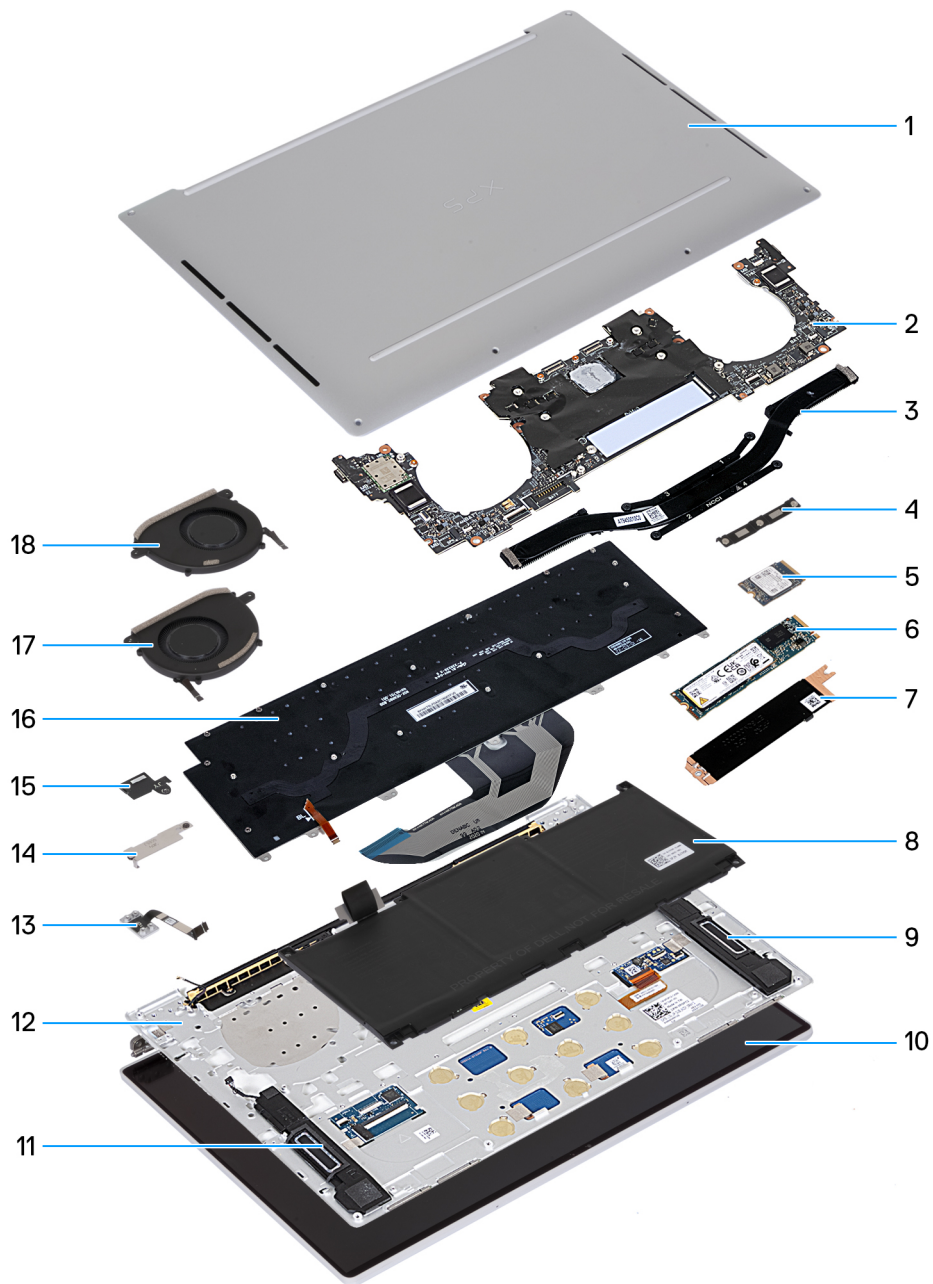



Figure 9. Major components of your computer

1. Base cover
2. System board
3. Heat sink
4. Display-assembly cable bracket
5. M.2 2230 solid state drive, or
6. M.2 2280 solid state drive
7. M.2 solid state drive thermal plate
8. Battery
9. Left speaker
10. Display assembly
11. Right speaker
12. Palm-rest and keyboard assembly
13. Power button
14. Battery-connector bracket

15. Wireless-module bracket
16. Keyboard
17. Right/video fan
18. Left/processor fan

 **NOTE:** Dell provides a list of components and their part numbers for the original computer configuration purchased. These parts are available according to warranty coverage purchased by the customer. Contact your Dell sales representative for purchase options.

Removing and installing Field Replaceable Units (FRUs)

The replaceable components in this chapter are Field Replaceable Units (FRUs).

 **CAUTION:** The information in this section is intended for authorized service technicians only.

 **CAUTION:** To avoid any potential damage to the component or loss of data, ensure that an authorized service technician replaces the Field Replaceable Units (FRUs).

 **CAUTION:** Dell Technologies recommends that these procedures be performed by trained technical repair specialists.

 **CAUTION:** Your warranty does not cover damages that may occur during FRU repairs that are not authorized by Dell Technologies.

 **NOTE:** The images in this document may differ from your computer depending on the configuration you ordered.

Base cover

Removing the base cover

 **CAUTION:** The information in this removal section is intended for authorized service technicians only.

Prerequisites

Follow the procedure in [Before working inside your computer](#).

About this task

The following images indicate the location of the base cover and provide a visual representation of the removal procedure.



6x
M2x3, T5



1x
M1.6x2



Figure 10. Removing the base cover



Figure 11. Removing the base cover



Figure 12. Removing the base cover

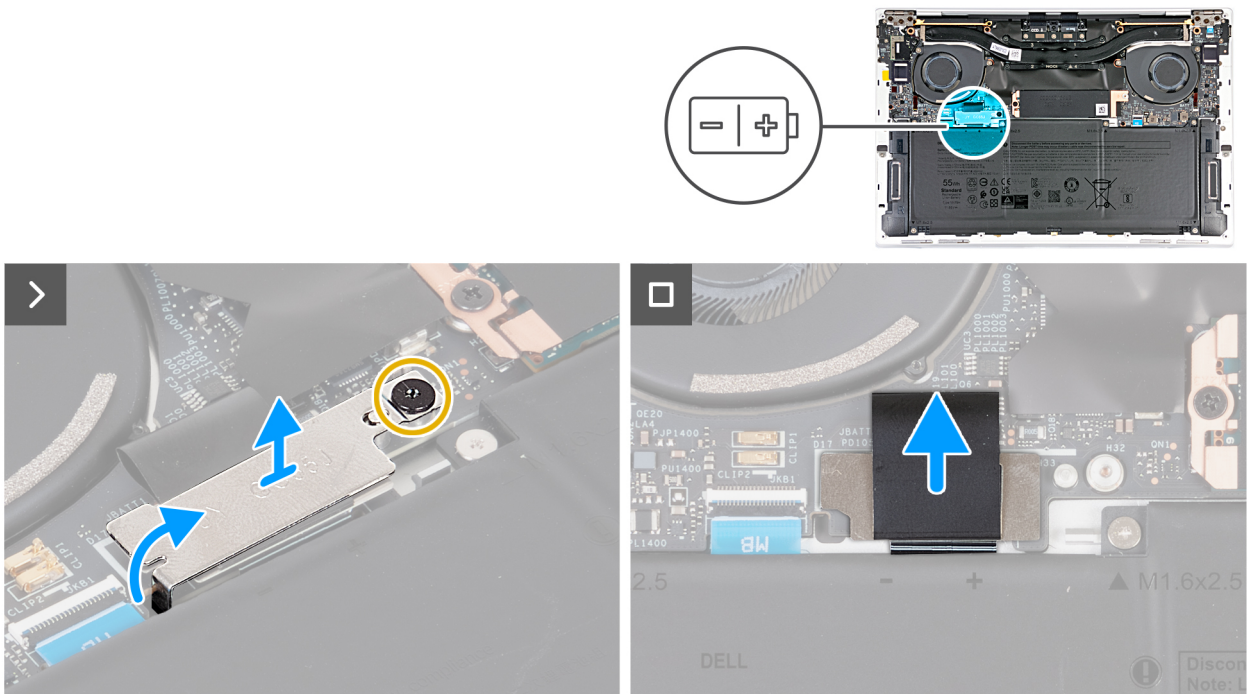

Figure 13. Removing the base cover

Steps

1. Remove the six screws (M2x3, T5) that secure the base cover to the palm-rest and keyboard assembly.

NOTE: A Torx #5 (T5) screwdriver is necessary to remove the six screws (M2x3, Torx 5).

2. Place your thumbs and fingers into the recess at the top edge of the base cover.
3. Use both thumbs to pry the base cover in order to release it from the palm-rest and keyboard assembly.

NOTE: Do not pull on or pry the base cover from where the display assembly hinges are, doing so may damage the base cover.

4. Move your hands to both sides of the base cover and lift the base cover off the palm-rest and keyboard assembly.
5. Loosen the captive screw (M1.6x2) that secures the battery-connector bracket to the system board.
6. Unhook and lift the battery-connector bracket off the system board.
7. Use the pull tab on the battery-power cable to disconnect the battery cable from the battery connector (JBATT1).

Installing the base cover

CAUTION: The information in this installation section is intended for authorized service technicians only.

Prerequisites

If you are replacing a component, remove the existing component before performing the installation process.

About this task

The following images indicate the location of the base cover and provide a visual representation of the installation procedure.

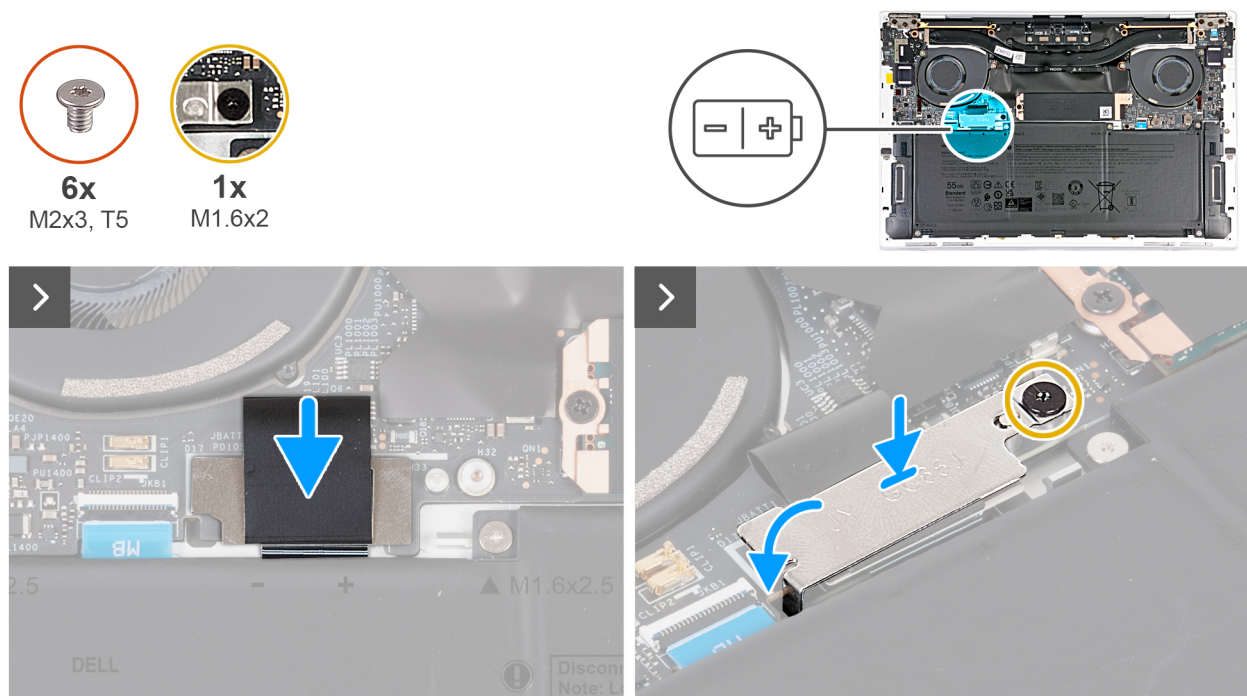

Figure 14. Installing the base cover





Figure 15. Installing the base cover



Figure 16. Installing the base cover

Steps

1. Connect the battery cable to the connector (JBATT1) on the system board.
2. Align the battery-connector bracket over the battery connector on the system board.
3. Slide the hook at the end of the battery-connector bracket under the system board. Ensure the hook fits into the underside of the system board.
4. Tighten the captive screw (M1.6x2) to secure the bracket to the system board. Ensure that the stud on the system board fits into its opening on the battery-connector bracket.
5. Place and snap the base cover into place on the palm-rest and keyboard assembly.
 -  **NOTE:** Align the screw holes on the base cover with the screw holes on the palm-rest and keyboard assembly before applying slight pressure to the base cover.
6. Replace the six screws (M2x3, T5) that secure the base cover to the palm-rest and keyboard assembly.
 -  **NOTE:** A Torx #5 (T5) screwdriver is necessary to install the six screws (M2x3, Torx 5).

Next steps

1. Follow the procedure in [After working inside your computer](#).

Battery

Rechargeable Li-ion battery precautions

WARNING:

- Exercise caution when handling rechargeable Li-ion batteries.
- Discharge the battery completely before removing it. Disconnect the AC power adapter from the computer and operate the computer solely on battery power—the battery is fully discharged when the computer no longer turns on when the power button is pressed.
- Do not crush, drop, mutilate, or penetrate the battery with foreign objects.
- Do not expose the battery to high temperatures, or disassemble battery packs and cells.
- Do not apply pressure to the surface of the battery.
- Do not bend the battery.
- Do not use tools of any kind to pry on or against the battery.
- To prevent accidental puncture or damage to the battery and other components, ensure that no screws are lost or misplaced during the servicing of the computer.
- Always purchase genuine batteries from [Dell Site](#) or authorized Dell partners and resellers.
- Swollen batteries should not be used and should be replaced and disposed properly. For guidelines on how to handle and replace swollen rechargeable Li-ion batteries, see [Handling swollen rechargeable Li-ion batteries](#).

Removing the battery

 **CAUTION:** The information in this removal section is intended for authorized service technicians only.

Prerequisites

1. Follow the procedure in [Before working in your computer](#).
2. Remove the [base cover](#).

About this task

 **CAUTION:** Removing the battery resets the BIOS setup settings to default. It is recommended that you note the BIOS setup settings before removing the battery.

The following images indicate the location of the battery and provide a visual representation of the removal procedure.

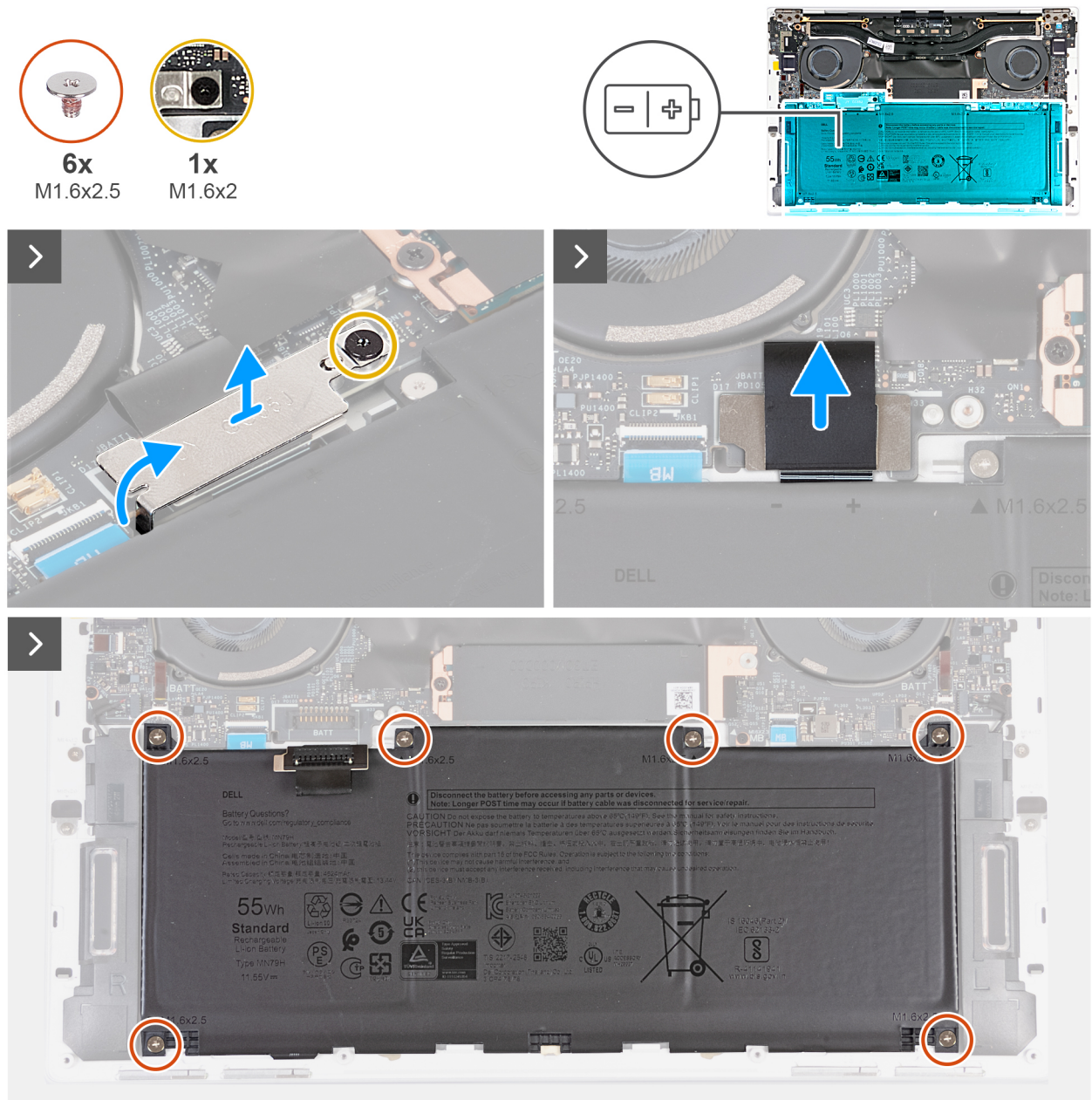

Figure 17. Removing the battery

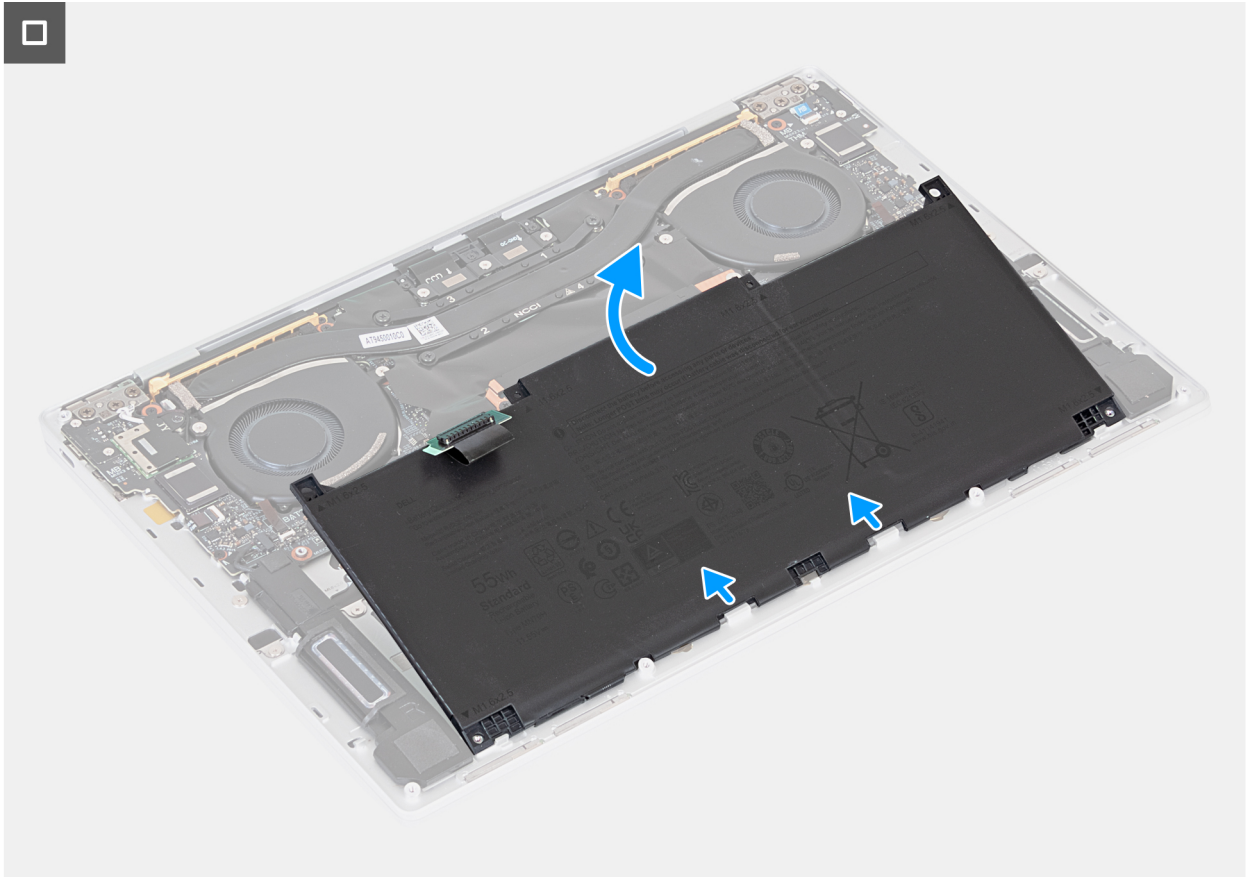

Figure 18. Removing the battery

Steps

1. Loosen the captive screw (M1.6x2) that secures the battery-connector bracket to the system board.
2. Unhook and lift the battery-connector bracket off the system board.

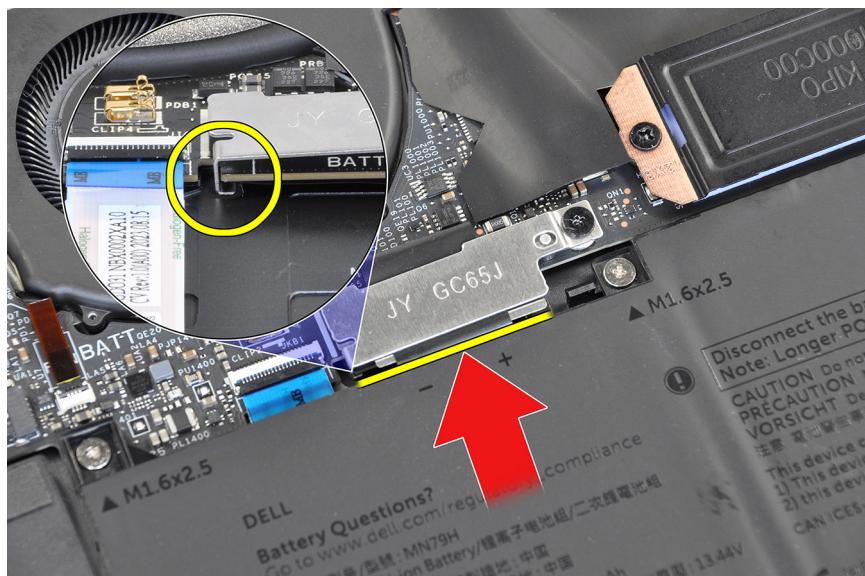

Figure 19. Battery-connector bracket

3. Use the pull tab on the battery cable to disconnect the battery cable from the battery connector (JBATT1) on the system board.

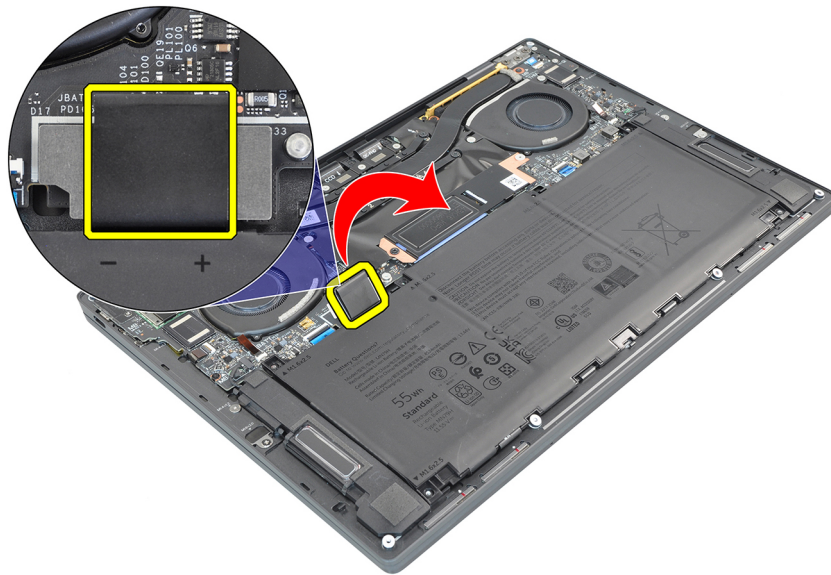

Figure 20. Use pull tab on battery cable

4. Remove the six screws (M1.6x2.5) that secure the battery to the palm-rest and keyboard assembly.
5. Use the pull tab to lift the battery slightly from its top edge. This action releases the battery from the two hooks that are located near the bottom edge of the palm-rest and keyboard assembly.

CAUTION: Do not lift the battery at more than an angle of 30 degrees to avoid damage to the battery and the palm-rest and keyboard assembly.

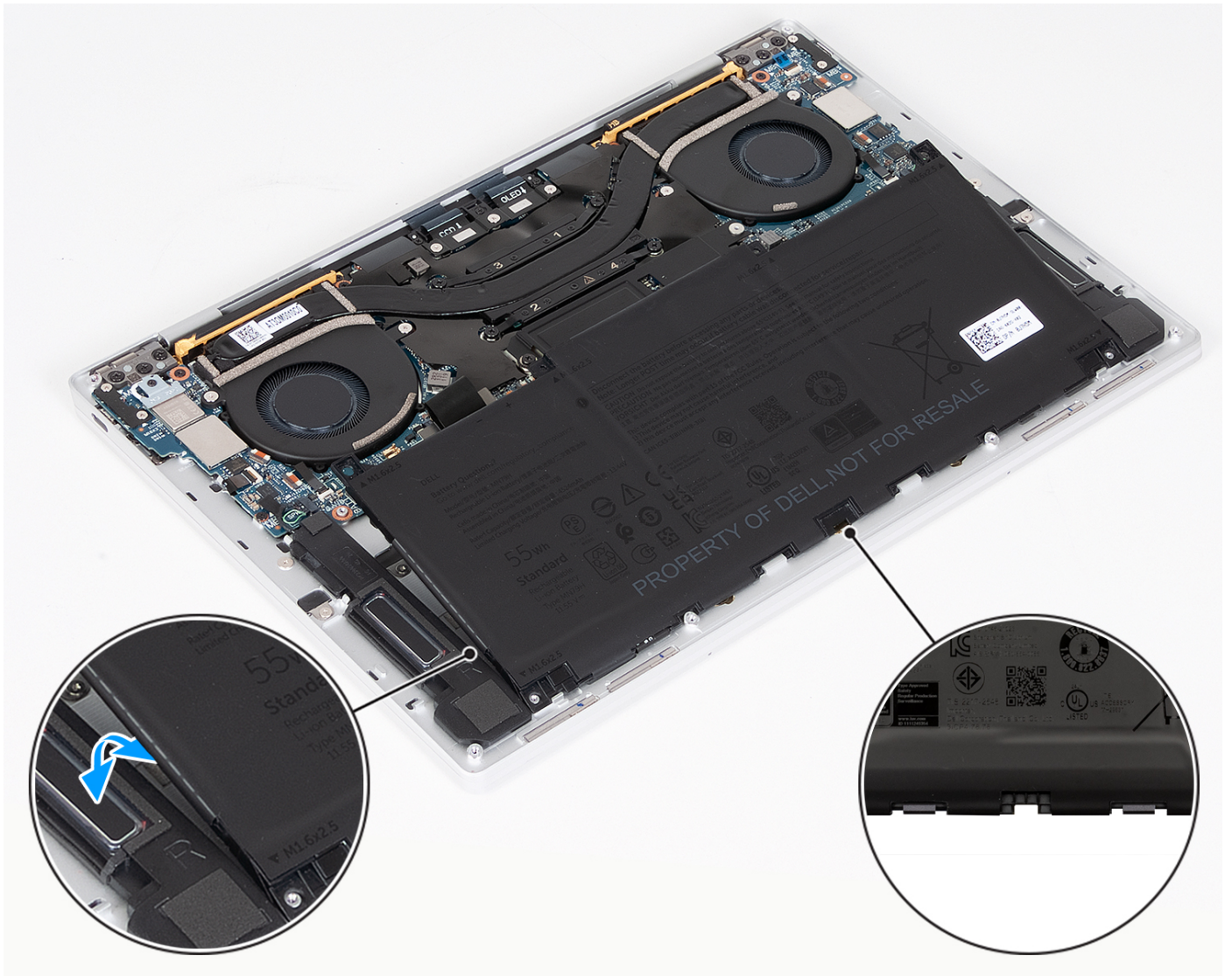

Figure 21. Lift the battery at an angle less than 30 degrees

6. Slide the battery towards the back and lift the battery off the palm-rest and keyboard assembly.

Installing the battery

CAUTION: The information in this installation section is intended for authorized service technicians only.

Prerequisites

If you are replacing a component, remove the existing component before performing the installation process.

About this task

CAUTION: Removing the battery resets the BIOS setup settings to default. It is recommended that you note the BIOS setup settings before removing the battery.

The following images indicate the location of the battery and provide a visual representation of the installation procedure.



6x
M1.6x2.5



1x
M1.6x2

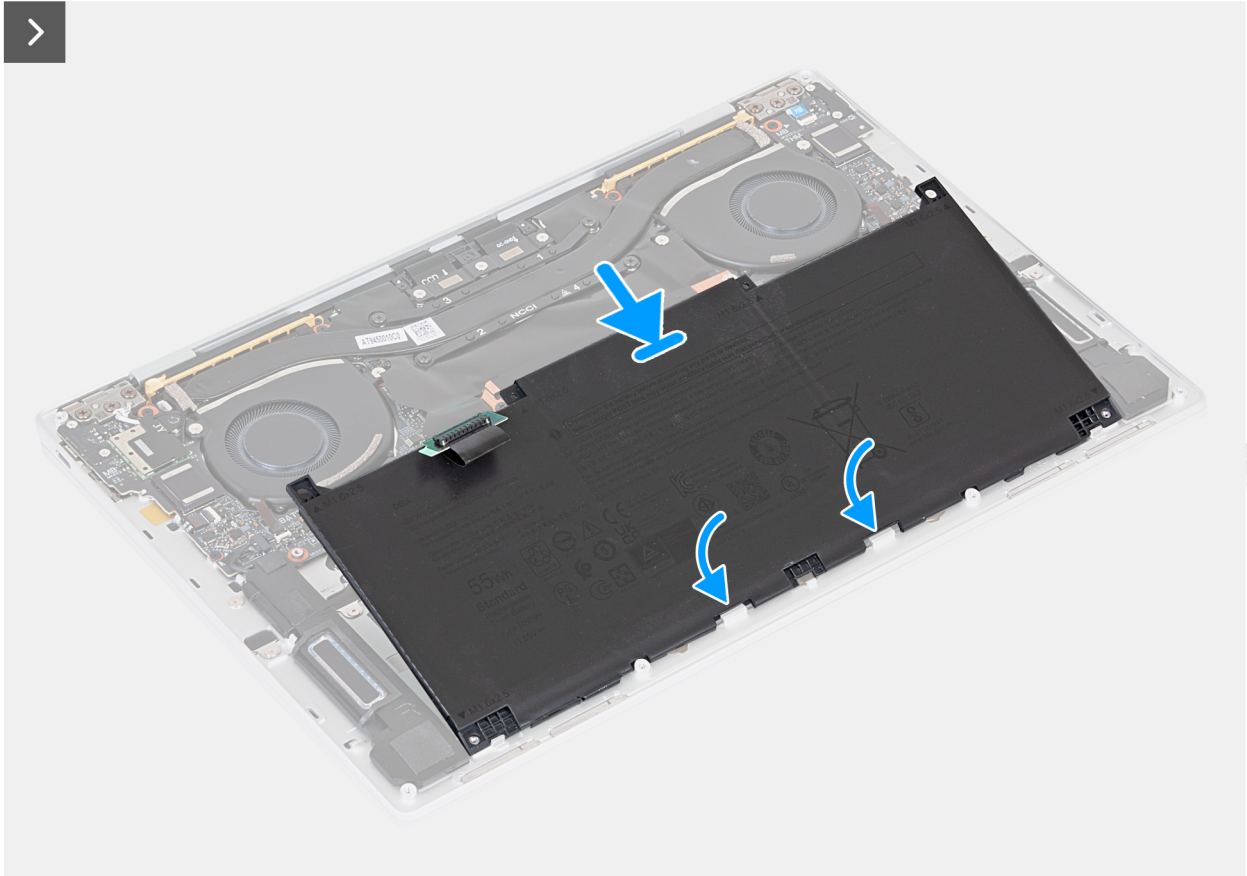
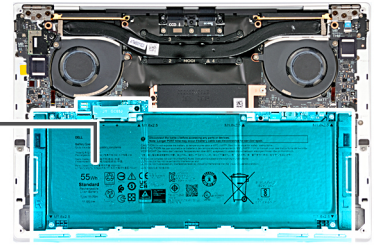
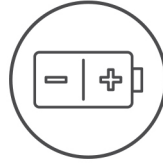

Figure 22. Installing the battery

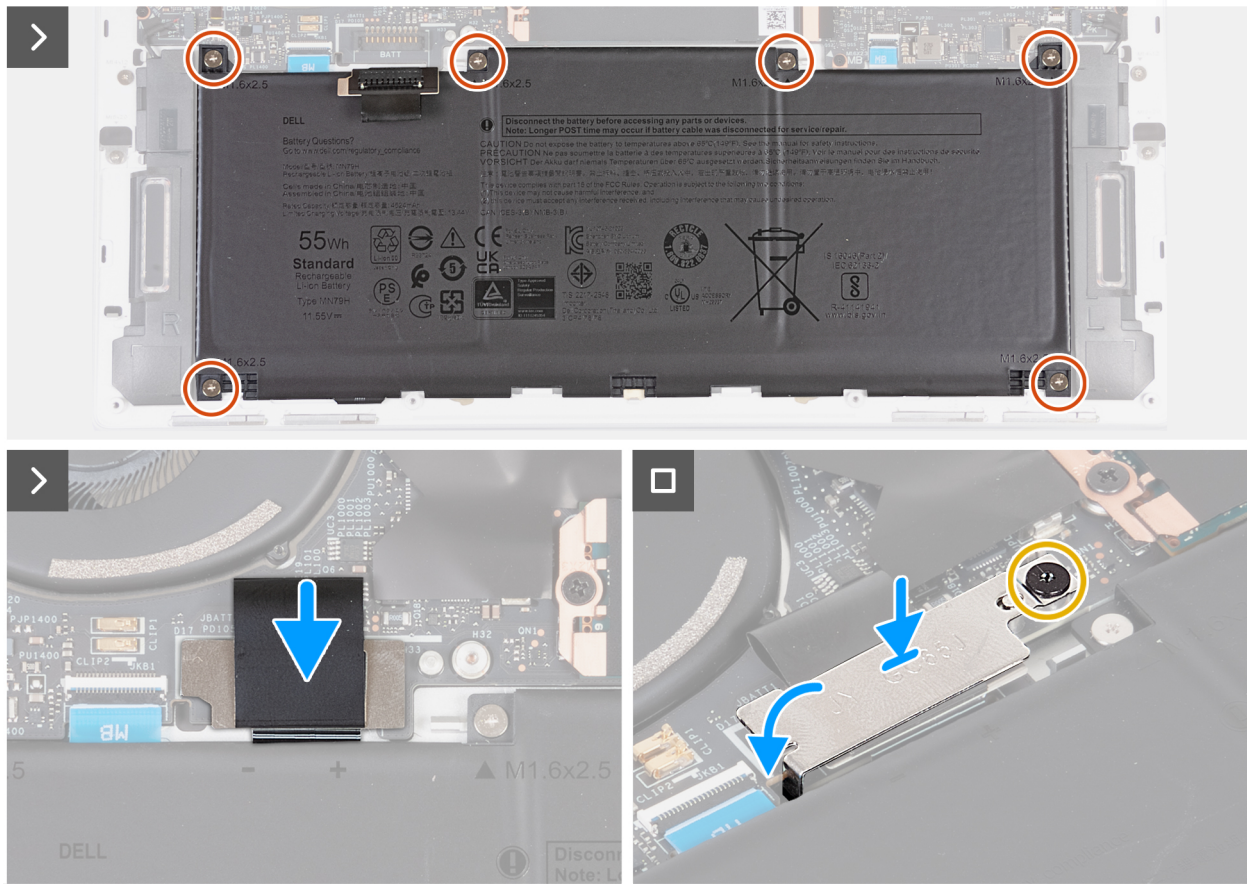

Figure 23. Installing the battery

Steps

1. Align the edge of the battery at an angle so that the cutouts on the battery fit into the hooks on the palm-rest and keyboard assembly. Align the two screw holes on the battery with the screw holes on the palm-rest and keyboard assembly as well.

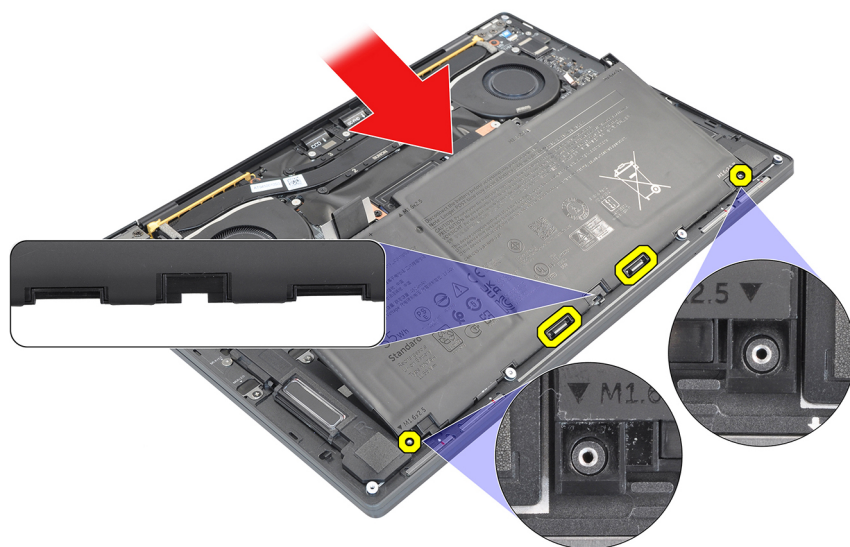

Figure 24. Align the battery

2. Lower the battery to the palm-rest and keyboard assembly until it fits into the battery section of the palm-rest and keyboard assembly.
3. Replace the six screws (M1.6x2.5) to secure the battery to the palm-rest and keyboard assembly.

NOTE: Align the screw holes on the base cover with the screw holes on the palm-rest and keyboard assembly before replacing the screws.

4. Connect the battery cable to the connector (JBATT1) on the system board.
5. Line up the battery-connector bracket over the battery connector on the system board.
6. Slide the hook at the end of the battery-connector bracket under the system board. Ensure the hook fits into the underside of the system board.
7. Tighten the captive screw (M1.6x2) to secure the bracket to the system board. Ensure that the stud on the system board fits into its opening on the battery-connector bracket.



Figure 25. Battery-connector bracket

Next steps

1. Install the [base cover](#).
2. Follow the procedure in [After working inside your computer](#).

Solid state drive (SSD)

Removing the M.2 2230 solid state drive

CAUTION: The information in this removal section is intended for authorized service technicians only.

Prerequisites

1. Follow the procedure in [Before working in your computer](#).
2. Remove the [base cover](#).

About this task

- NOTE:** Depending on the configuration ordered, your computer may support an M.2 2230 solid state drive or an M.2 2280 solid state drive.
- NOTE:** A thermal pad is adhered to the system board under the M.2 solid state drive. If the thermal pad is inadvertently separated from the system board during the removal or replacement of the M.2 solid state drive, readhere the thermal pad to the system board.

NOTE: This procedure applies only to computers shipped with an M.2 2230 solid state drive.

The following images indicate the location of the M.2 2230 solid state drive and provide a visual representation of the removal procedure.

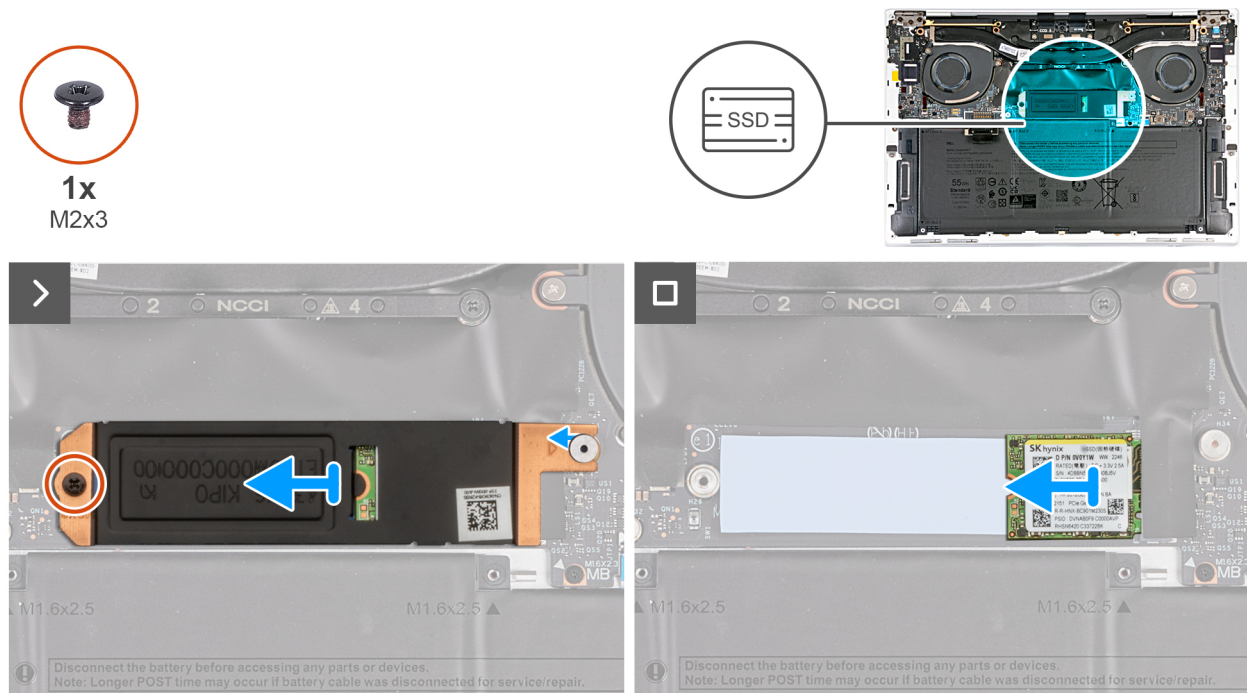

Figure 26. Removing the M.2 2230 solid-state drive

Steps

1. Remove the screw (M2x3) that secures the M.2 solid state drive shield to the system board.
2. Slide the M.2 solid state drive shield off the system board.
3. Slide the M.2 2230 solid state drive out of the solid state drive slot on the system board.

NOTE: A thermal pad is adhered to the system board under the M.2 solid state drive. If the thermal pad is inadvertently separated from the system board during the removal or replacement of the M.2 solid state drive, readhere the thermal pad to the system board.

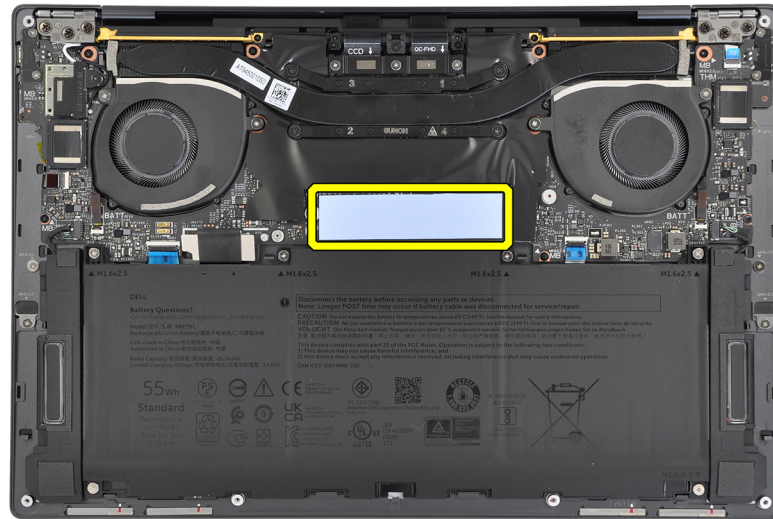

Figure 27. Thermal pad

Installing the M.2 2230 solid state drive

CAUTION: The information in this installation section is intended for authorized service technicians only.

Prerequisites

If you are replacing a component, remove the existing component before performing the installation process.

About this task

- NOTE:** Depending on the configuration ordered, your computer may support an M.2 2230 solid state drive or an M.2 2280 solid state drive.
- NOTE:** A thermal pad is adhered to the system board under the M.2 solid state drive. If the thermal pad is inadvertently separated from the system board during the removal or replacement of the M.2 solid state drive, readhere the thermal pad to the system board.
- NOTE:** This procedure applies only to computers shipped with an M.2 2230 solid state drive.

The following images indicate the location of the M.2 2230 solid state drive and provide a visual representation of the installation procedure.

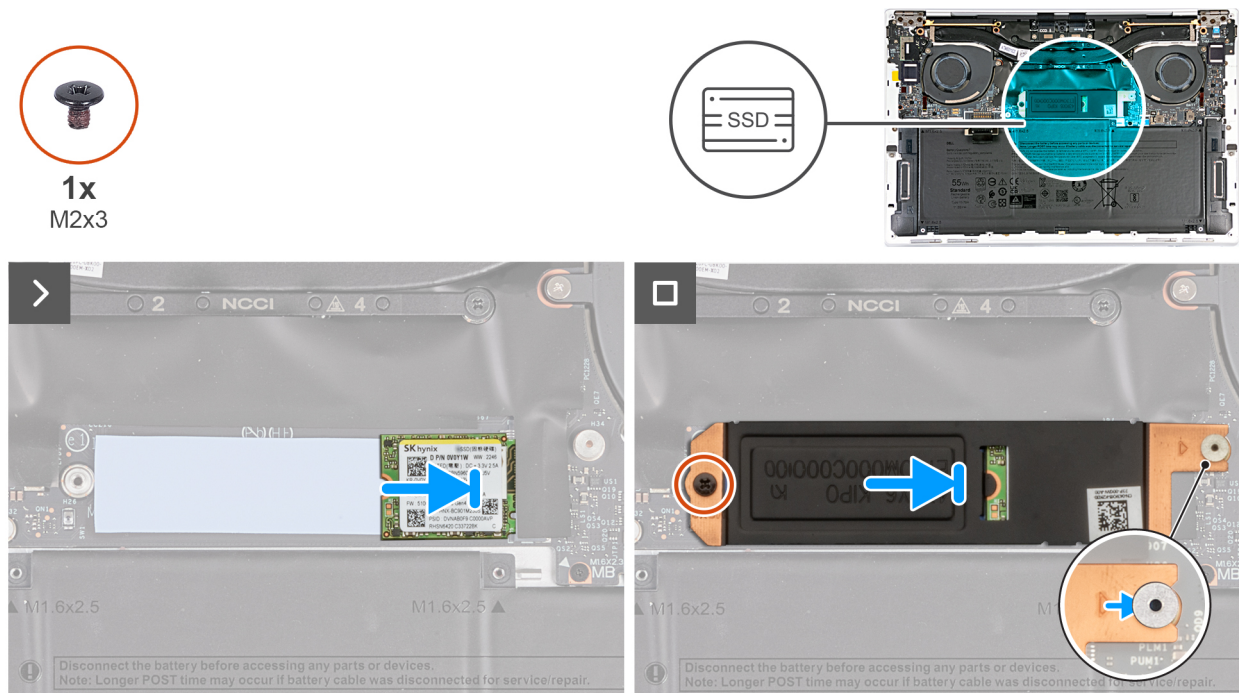

Figure 28. Installing the M.2 2230 solid-state drive

Steps

1. **i** **NOTE:** A thermal pad is adhered to the system board under the M.2 solid state drive. If the thermal pad is inadvertently separated from the system board during the removal or replacement of the M.2 solid state drive, readhere the thermal pad to the system board.



Figure 29. Thermal pad

2. Align the notch on the M.2 2230 solid state drive with the tab on the solid state drive slot on the system board.
3. Slide the M.2 2230 solid state drive into the solid state drive slot.
3. Insert the tab of the M.2 solid state drive shield into the peg on the system board.

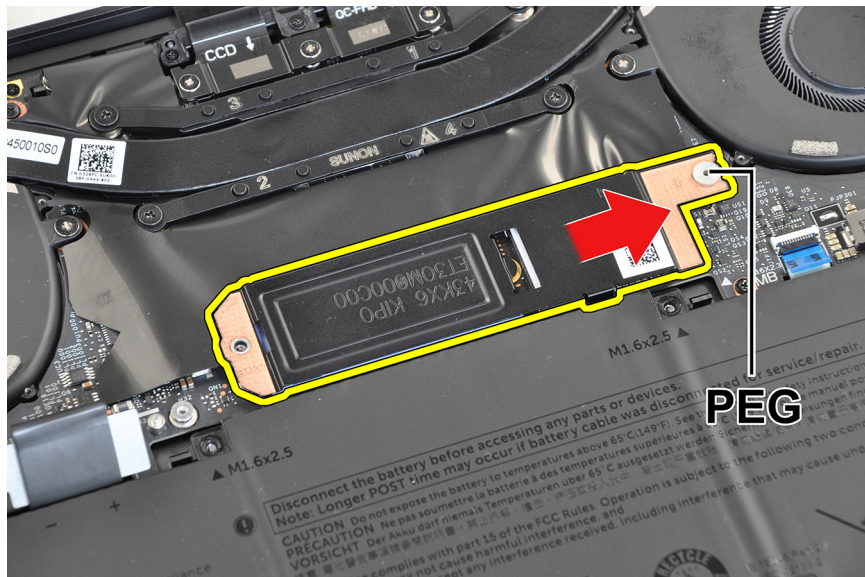

Figure 30. Insert the M.2 solid state drive shield

4. Replace the screw (M2x3) that secures the M.2 solid state drive shield to the system board.

Next steps

1. Install the [base cover](#).
2. Follow the procedure in [After working inside your computer](#).

Removing the M.2 2280 solid state drive

⚠ CAUTION: The information in this removal section is intended for authorized service technicians only.

Prerequisites

1. Follow the procedure in [Before working in your computer](#).
2. Remove the [base cover](#).

About this task

- i NOTE:** Depending on the configuration ordered, your computer may support an M.2 2230 solid state drive or an M.2 2280 solid state drive.
- i NOTE:** A thermal pad is adhered to the system board under the M.2 solid state drive. If the thermal pad is inadvertently separated from the system board during the removal or replacement of the M.2 solid state drive, readhere the thermal pad to the system board.
- i NOTE:** This procedure applies only to computers shipped with an M.2 2280 solid state drive.

The following images indicate the location of the M.2 2280 solid state drive and provide a visual representation of the removal procedure.

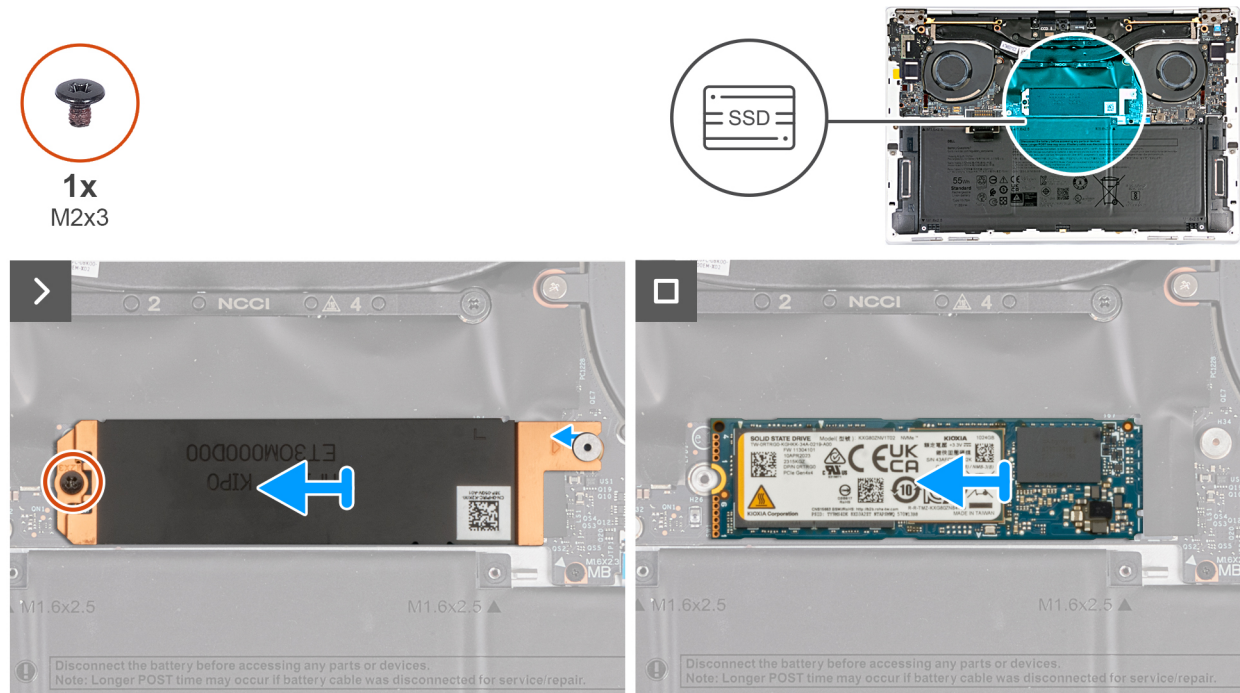

Figure 31. Removing the M.2 2280 solid-state drive

Steps

1. Remove the screw (M2x3) that secures the M.2 solid state drive shield to the system board.
2. Lift the M.2 solid state drive shield off the system board.
3. Slide the M.2 2280 solid state drive out of the solid state drive slot.
4. Lift the M.2 2280 solid state drive assembly off the system board.

i NOTE: A thermal pad is adhered to the system board under the M.2 solid state drive. If the thermal pad is inadvertently separated from the system board during the removal or replacement of the M.2 solid state drive, readhere the thermal pad to the system board.

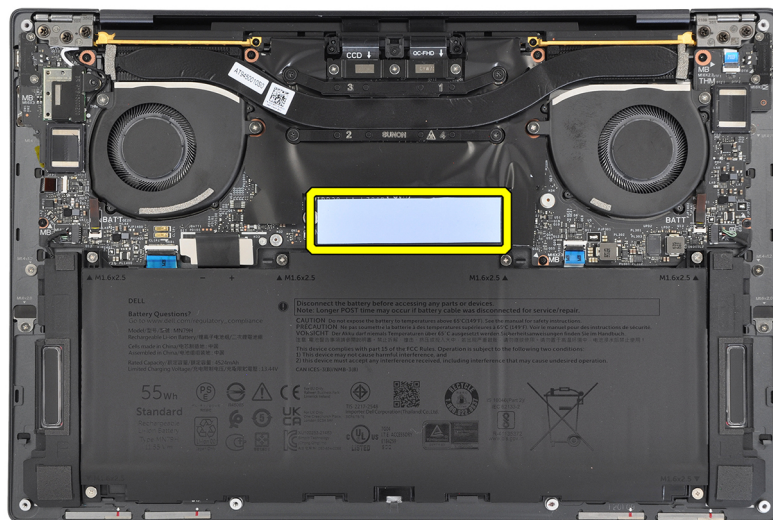

Figure 32. Thermal pad

Installing the M.2 2280 solid state drive

CAUTION: The information in this installation section is intended for authorized service technicians only.

Prerequisites

If you are replacing a component, remove the existing component before performing the installation process.

About this task

- NOTE:** Depending on the configuration ordered, your computer may support an M.2 2230 solid state drive or an M.2 2280 solid state drive.
- NOTE:** A thermal pad is adhered to the system board under the M.2 solid state drive. If the thermal pad is inadvertently separated from the system board during the removal or replacement of the M.2 solid state drive, readhere the thermal pad to the system board.
- NOTE:** This procedure applies only to computers shipped with an M.2 2280 solid state drive.

The following images indicate the location of the M.2 2280 solid state drive and provide a visual representation of the installation procedure.

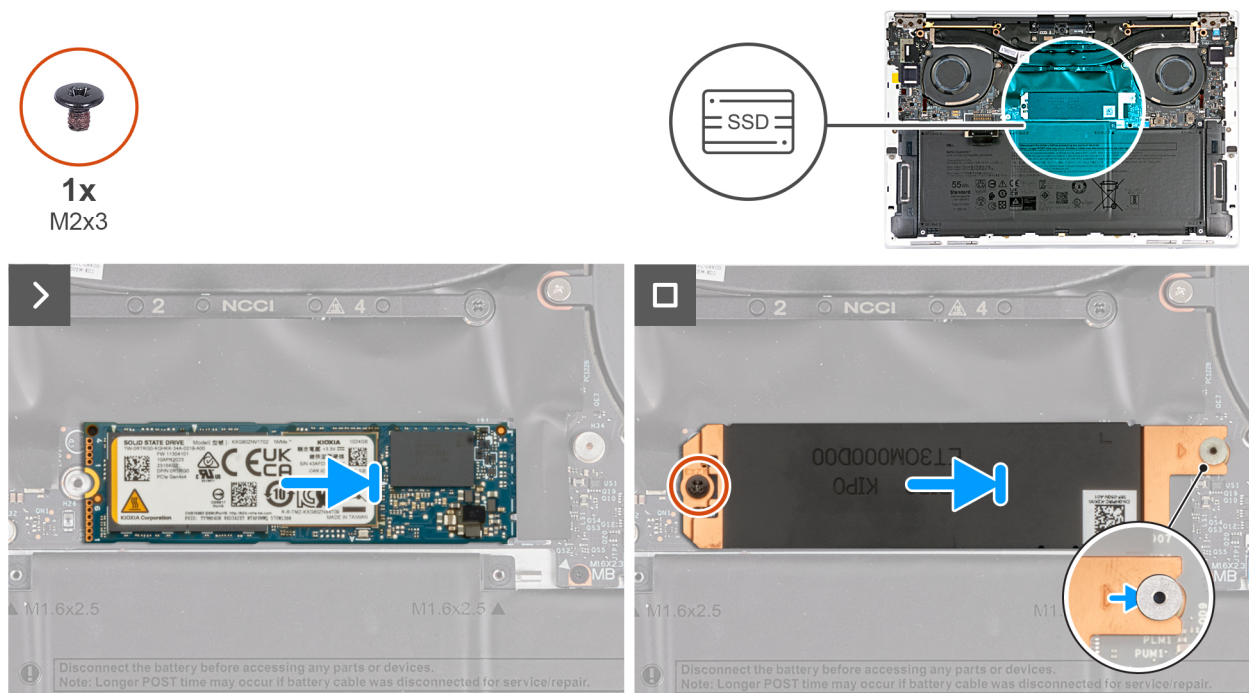

Figure 33. Installing the M.2 2280 solid-state drive

Steps

- NOTE:** A thermal pad is adhered to the system board under the M.2 solid state drive. If the thermal pad is inadvertently separated from the system board during the removal or replacement of the M.2 solid state drive, readhere the thermal pad to the system board.



Figure 34. Thermal pad

Align the notch on the M.2 2280 solid state drive with the tab on the solid state drive slot.

2. Slide the M.2 2280 solid state drive into the solid state drive slot.
3. Insert the tab of the M.2 solid state drive shield into the peg on the system board.

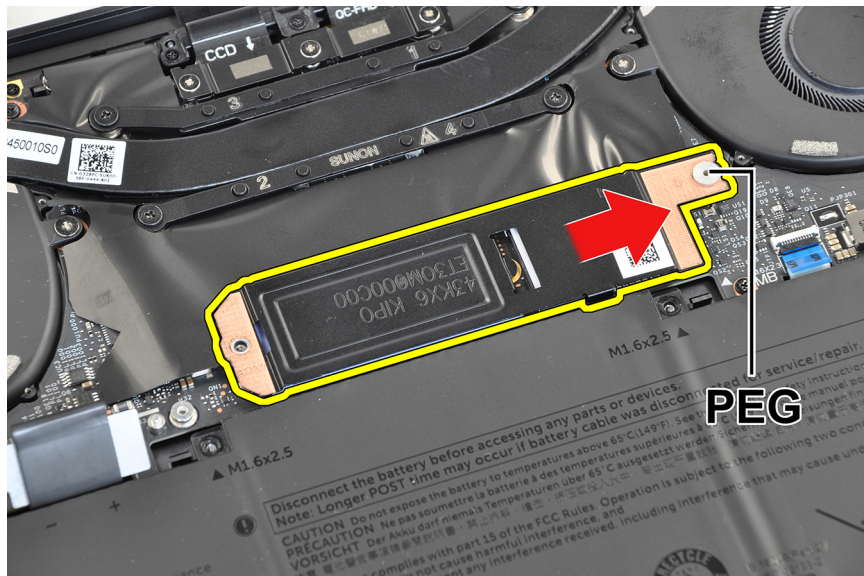

Figure 35. Insert M.2 solid state drive shield

4. Replace the screw (M2x3) that secures the M.2 solid state drive shield to the system board.

Next steps

1. Install the [base cover](#).
2. Follow the procedure in [After working inside your computer](#).

Fans

Removing the fans

CAUTION: The information in this removal section is intended for authorized service technicians only.

Prerequisites

1. Follow the procedure in [Before working in your computer](#).
2. Remove the [base cover](#).

About this task

The following images indicate the location of the fans and provide a visual representation of the removal procedure.

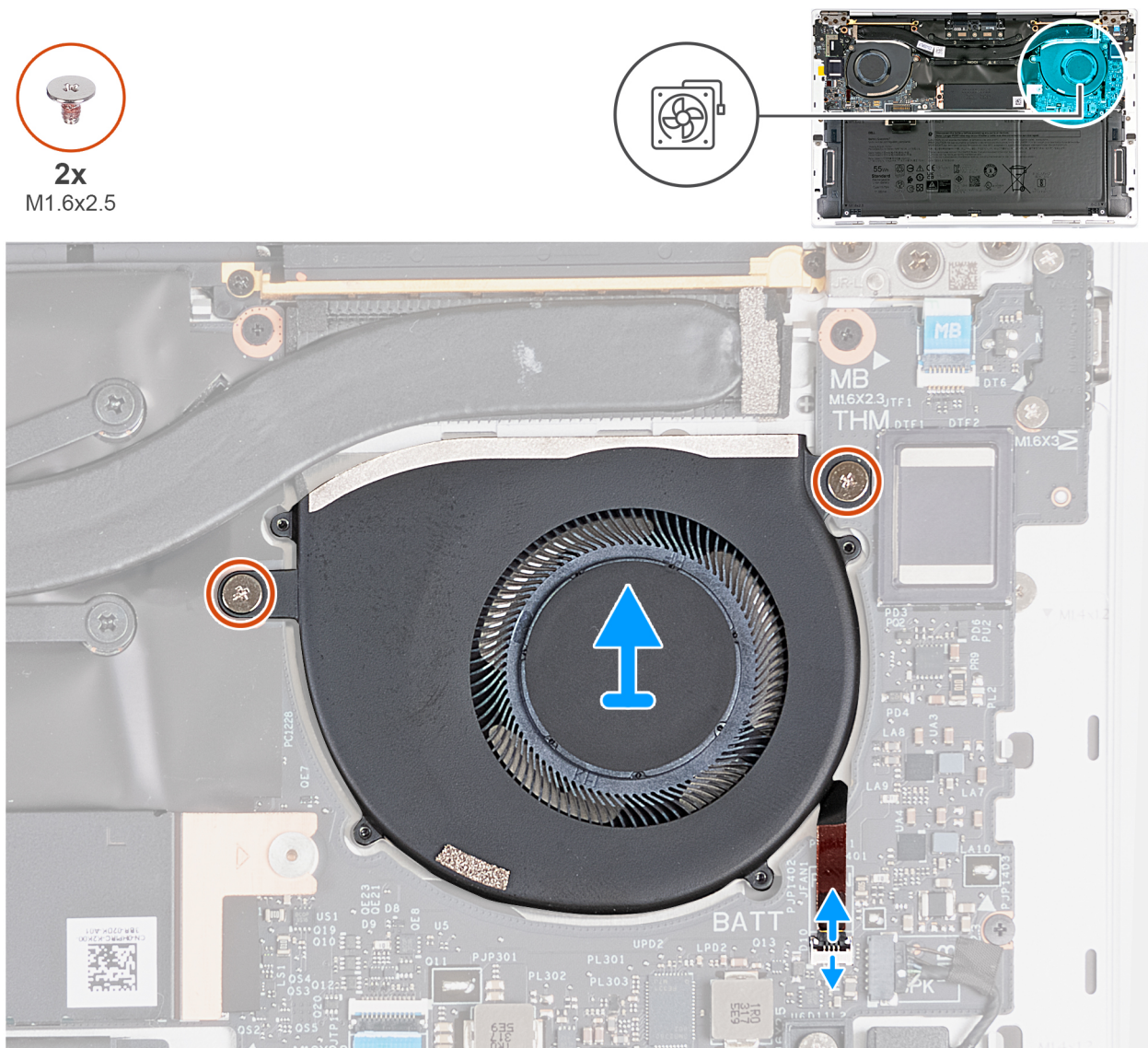

Figure 36. Removing the left/processor fan

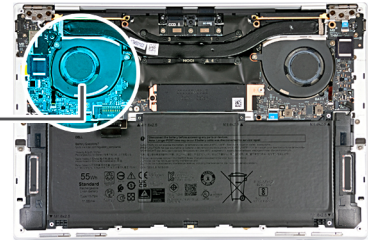
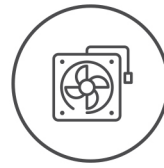

Figure 37. Removing the right/video fan

Steps

1. Open the latch on the left/processor-fan cable connector, then use the pull tab of the left/processor-fan cable to disconnect it from the connector (JFAN1) on the system board.
2. Remove the two screws (M1.6x2.5) that secure the left/processor fan to the system board.
3. Lift the left/processor fan off the system board.
4. Open the latch on the right/video-fan cable, then use the pull tab of the right/video-fan cable to disconnect it from the connector (JFAN2) on the system board.
5. Remove the two screws (M1.6x2.5) that secure the right/video fan to the system board.
6. Lift the right/video fan off the system board.

Installing the fans

⚠ CAUTION: The information in this installation section is intended for authorized service technicians only.

Prerequisites

If you are replacing a component, remove the existing component before performing the installation procedure.

About this task

The following images indicate the location of the fans and provides a visual representation of the installation procedure.



2x
M1.6x2.5

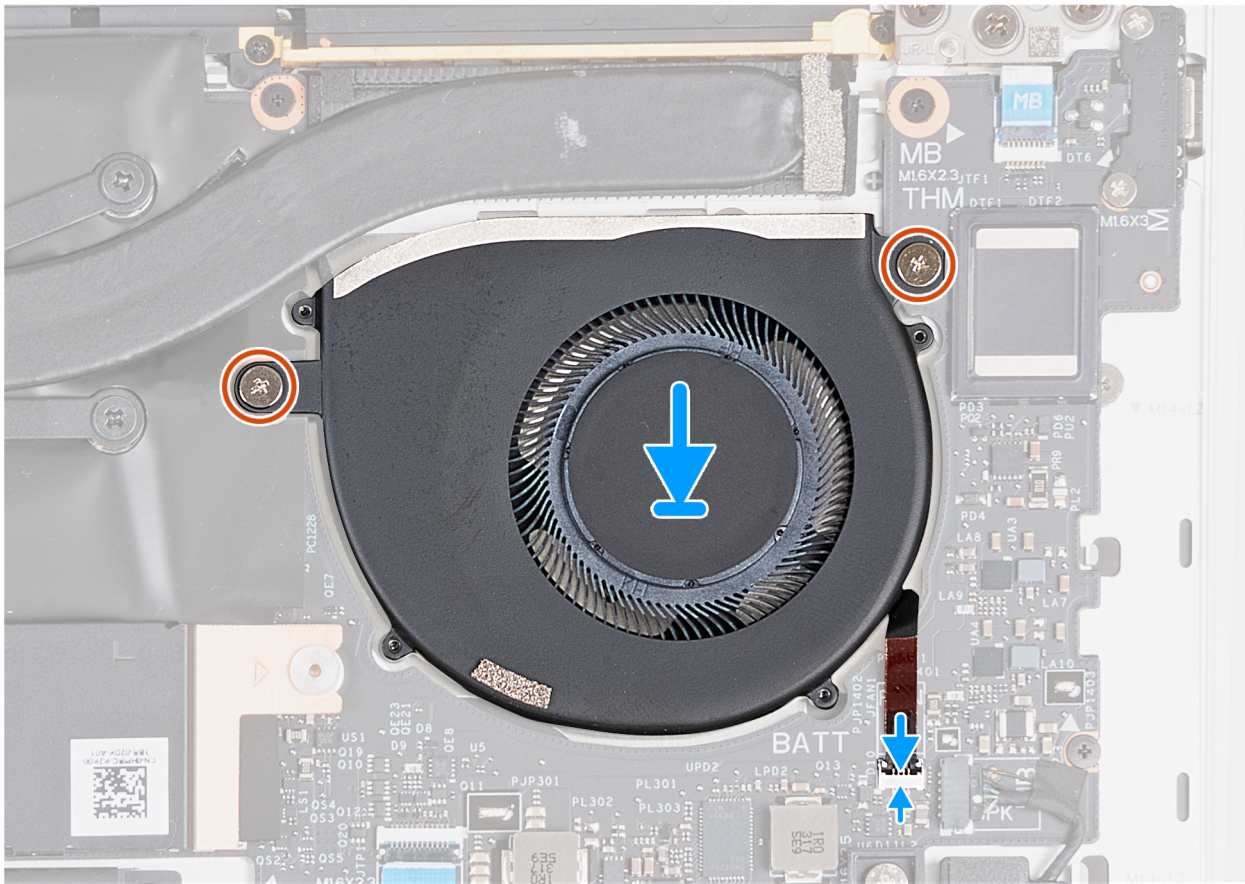
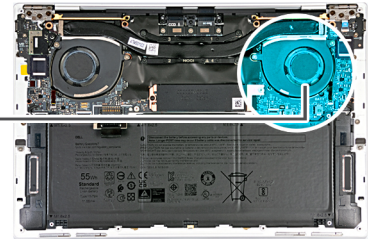
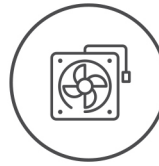

Figure 38. Installing the left/processor fan

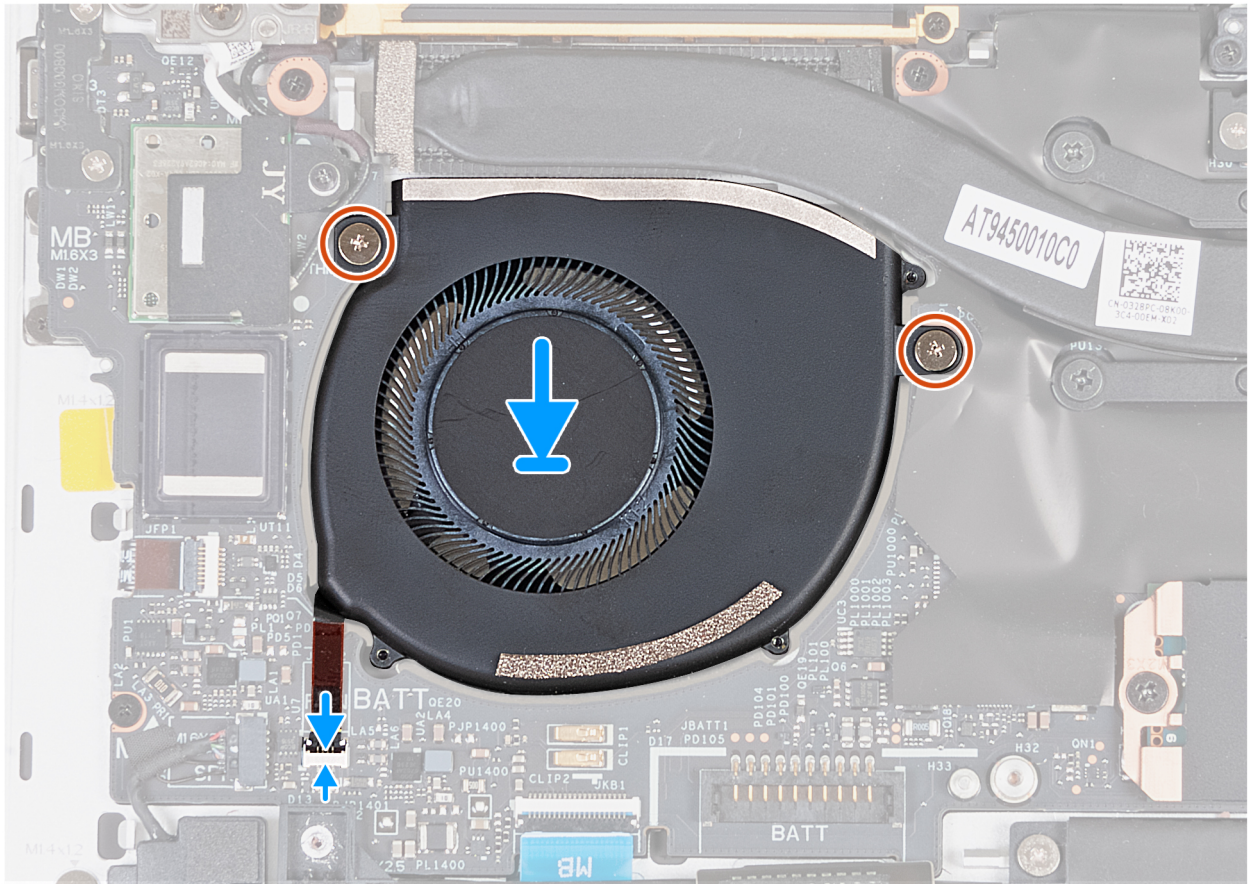
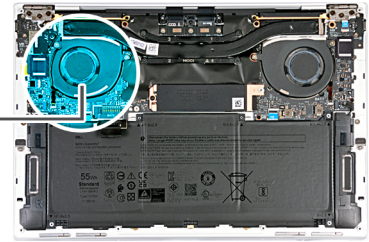
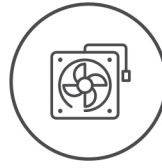

Figure 39. Installing the right/video fan

Steps

1. Align the screw holes of the left/processor fan with the screw holes of the system board.
2. Replace the two screws (M1.6x2.5) that secure the left/processor fan to the system board.
3. Connect the left/processor fan cable to the connector (JFAN1) on the system board and close the latch to secure the cable.
4. Align the screw holes of the right/video fan with the screw holes of the system board.
5. Replace the two screws (M1.6x2.5) that secure the right/video fan to the system board.
6. Connect the right/video fan cable to the connector (JFAN2) on the system board and close the latch to secure the cable.

Next steps

1. Install the [base cover](#).
2. Follow the procedure in [After working inside your computer](#).

Heat sink

Removing the heat sink

CAUTION: The information in this removal section is intended for authorized service technicians only.

Prerequisites

1. Follow the procedure in [Before working in your computer](#).
2. Remove the [base cover](#).

About this task

CAUTION: The heat sink may become hot during normal operation. Allow sufficient time for the heat sink to cool before you touch it.

NOTE: For maximum cooling of the processor, do not touch the heat transfer areas on the heat sink. The oils in your skin can reduce the heat transfer capability of the thermal grease.

The following images indicate the location of the heat sink and provide a visual representation of the removal procedure.

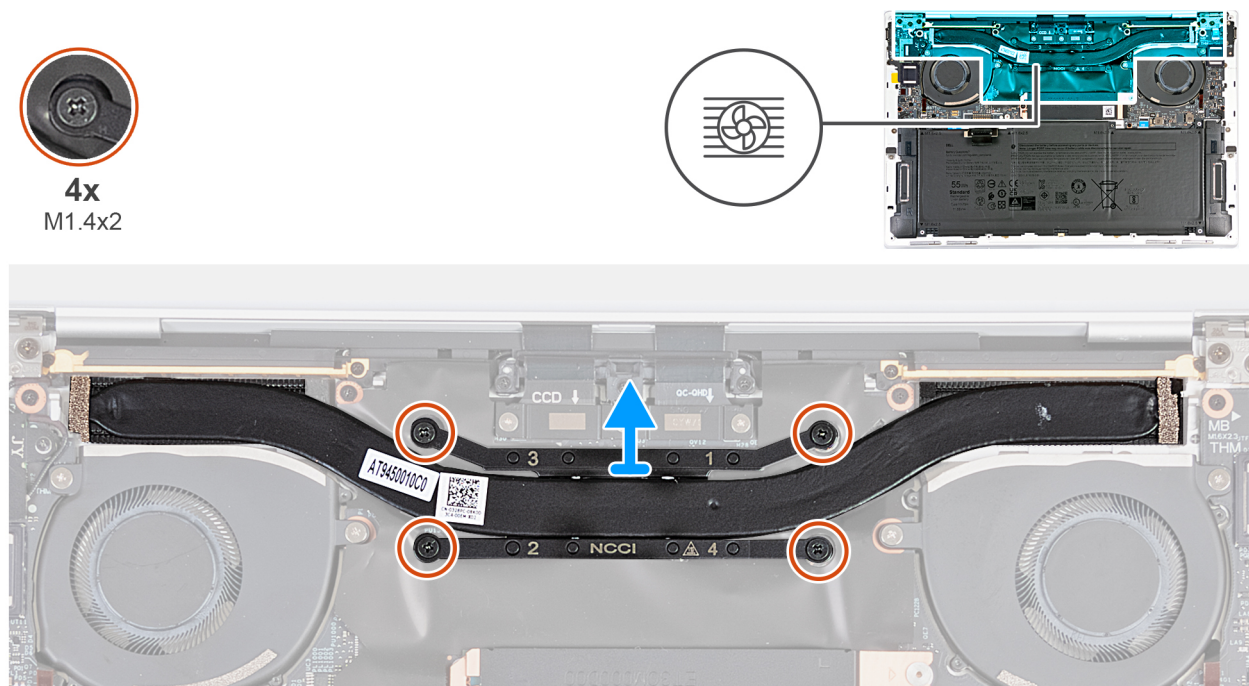

Figure 40. Removing the heat sink

Steps

1. In reverse sequential order (4>3>2>1) as indicated on the heat sink, loosen the four captive screws (M1.4x2) that secure the heat sink to the system board.
2. Lift the heat sink off the system board.

Installing the heat sink

CAUTION: The information in this installation section is intended for authorized service technicians only.

Prerequisites

If you are replacing a component, remove the existing component before performing the installation process.

About this task

- NOTE:** Incorrect alignment of the heat sink can damage the system board and processor.
- NOTE:** If either the system board or the heat sink is replaced, use the thermal grease that is provided in the kit to ensure that thermal conductivity is achieved.

The following images indicate the location of the heat sink and provide a visual representation of the installation procedure.

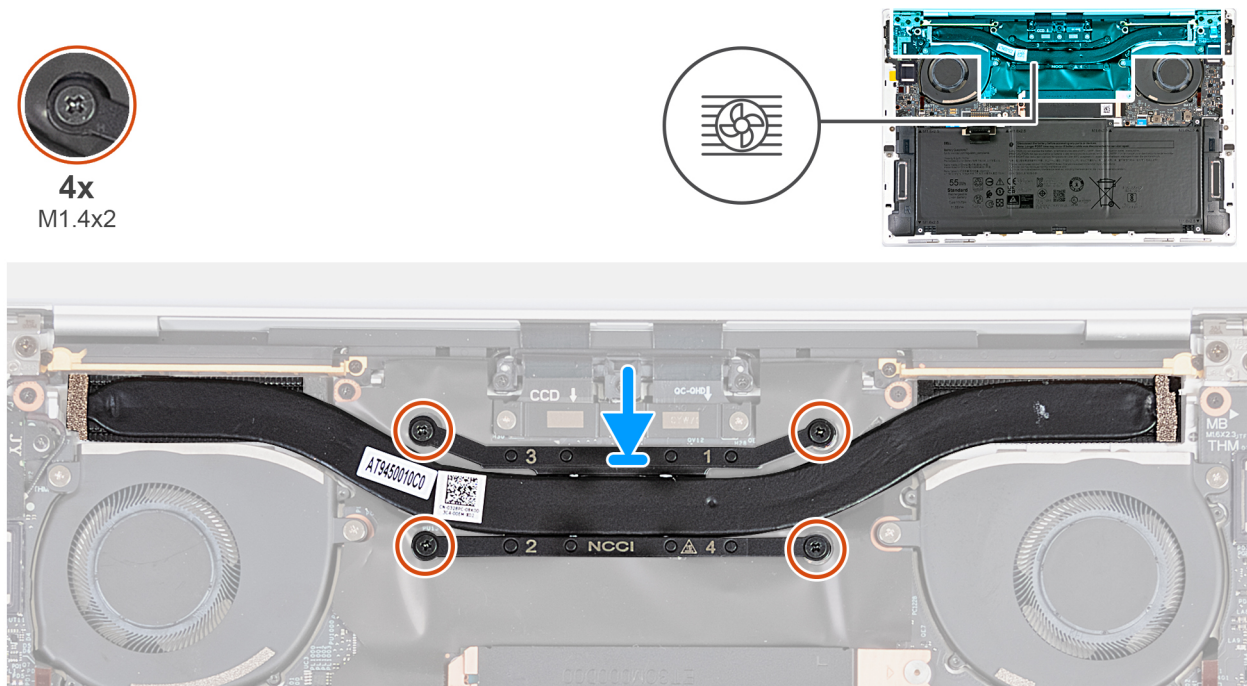

Figure 41. Installing the heat sink

Steps

1. Align the screw holes of the heat sink with the screw holes of the system board.
2. In sequential order (1>2>3>4) as indicated on the heat sink, tighten the four captive screws (M1.4x2) that secure the heat sink to the system board.

Next steps

1. Install the [base cover](#).
2. Follow the procedure in [After working inside your computer](#).

Display assembly

Removing the display assembly

CAUTION: The information in this removal section is intended for authorized service technicians only.

Prerequisites

1. Follow the procedure in [Before working in your computer](#).
2. Remove the [base cover](#).

About this task

The following images indicate the location of the display assembly and provide a visual representation of the removal procedure.

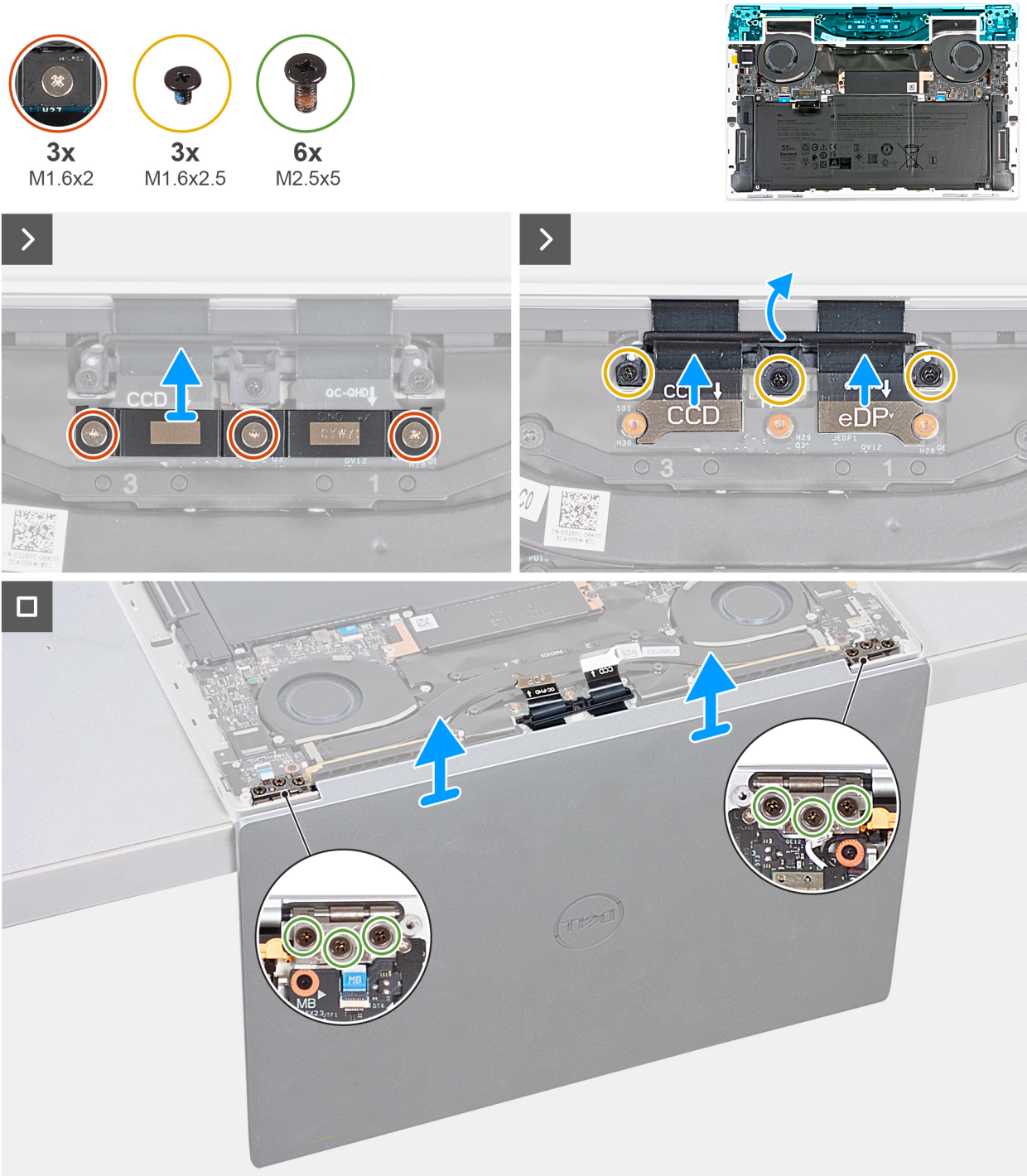

Figure 42. Removing the display assembly

Steps

1. Loosen the three captive screws (M1.6x2) that secure the display cable bracket to the system board.
2. Lift the display cable bracket off the system board.
3. Disconnect the camera cable from the camera cable connector (JCAM1) on the system board.
4. Disconnect the display cable from the display cable connector (JEDP1) on the system board.
5. Remove the three screws (M1.6x2.5) that secure the camera and display cable holder to the system board.

6. Open the display to a 90-degree angle and place the computer at the edge of a flat table.



Figure 43. Open display to 90-degree angle

NOTE: Ensure to maintain the angle throughout the removal process to minimize the risk of damaging the thin display panel when applying torque to install and remove screws from the computer.

7. Remove the three screws (M2.5x5) that secure the left hinge to the system board and the palm-rest and keyboard assembly.
8. Remove the three screws (M2.5x5) that secure the right hinge to the system board and the palm-rest and keyboard assembly.
9. Lift the display assembly off the palm-rest and keyboard assembly.
10. After performing all the above steps, you are left with the display assembly.

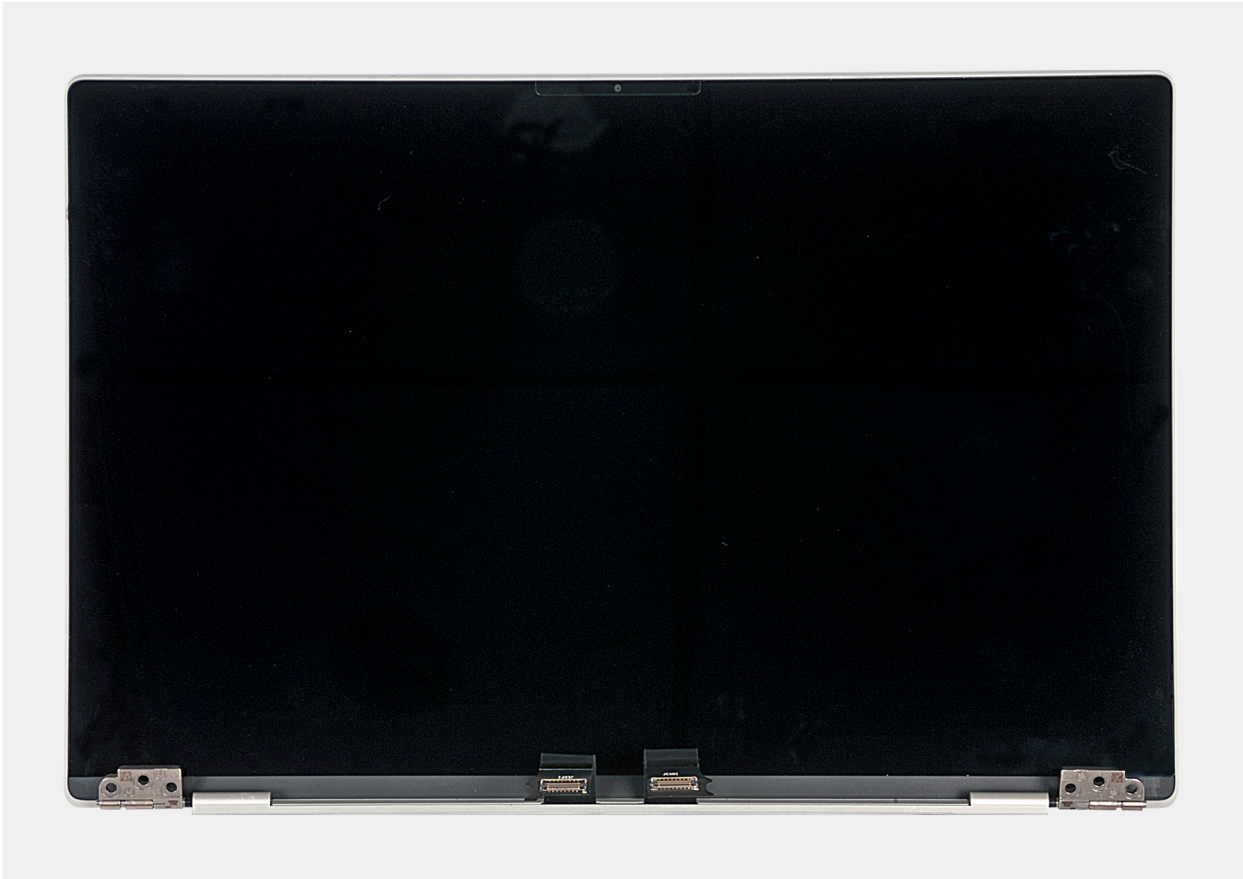

Installing the display assembly

CAUTION: The information in this installation section is intended for authorized service technicians only.

Prerequisites

If you are replacing a component, remove the existing component before performing the installation process.

About this task

The following images indicate the location of the display assembly and provide a visual representation of the installation procedure.

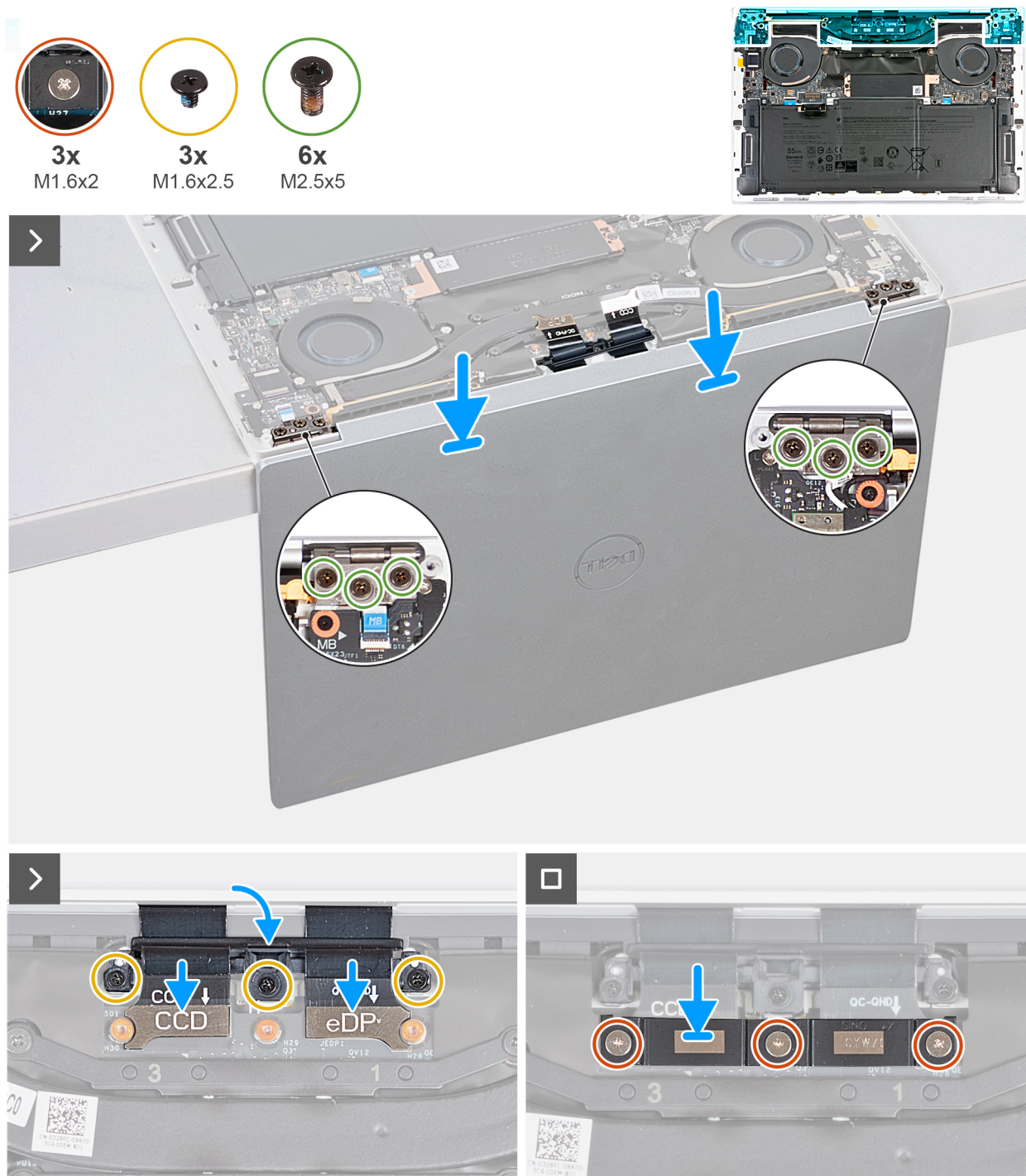

Figure 44. Installing the display assembly

Steps

1. Open the display assembly to a 90-degree angle and place the computer on the edge of a flat surface.
2. Place the palm-rest and keyboard assembly at the edge of a flat table.
3. Open the hinges of the display assembly to a 90-degree angle.
4. Align the screw holes of the palm-rest and keyboard assembly with the screw holes on the hinges of the display assembly.
5. Replace the three screws (M2.5x5) to secure the left hinge to the palm-rest and keyboard assembly.
6. Replace the three screws (M2.5x5) to secure the right hinge to the palm-rest and keyboard assembly.
7. Close the display assembly, turn the computer over and place it on the flat surface.
8. Slide the camera and display-assembly cable holder back to the system board.

9. Replace three screws (M1.6x2.5) that secure the camera and display-assembly cable holder to the system board.
10. Connect the camera cable to the camera cable connector (JCAM1) on the system board.
11. Connect the display cable to the display cable connector (JEDP1) on the system board.
12. Align the screw holes on the display-assembly cable bracket with the screw holes on the system board and tighten the three captive screws (M1.6x2) to secure the bracket.

Next steps

1. Install the [base cover](#).
2. Follow the procedure in [After working inside your computer](#).

System board

Removing the system board

CAUTION: The information in this removal section is intended for authorized service technicians only.

Prerequisites

1. Follow the procedure in [Before working in your computer](#).
2. Remove the [base cover](#).
3. Remove the [M.2 2230 solid-state drive](#) or [M.2 2280 solid-state drive](#) from the M.2 slot, whichever is applicable.
4. Remove the [battery](#).
5. Remove the [fans](#).
6. Remove the [heat sink](#).

About this task

The following image indicates the connectors and components on your system board.

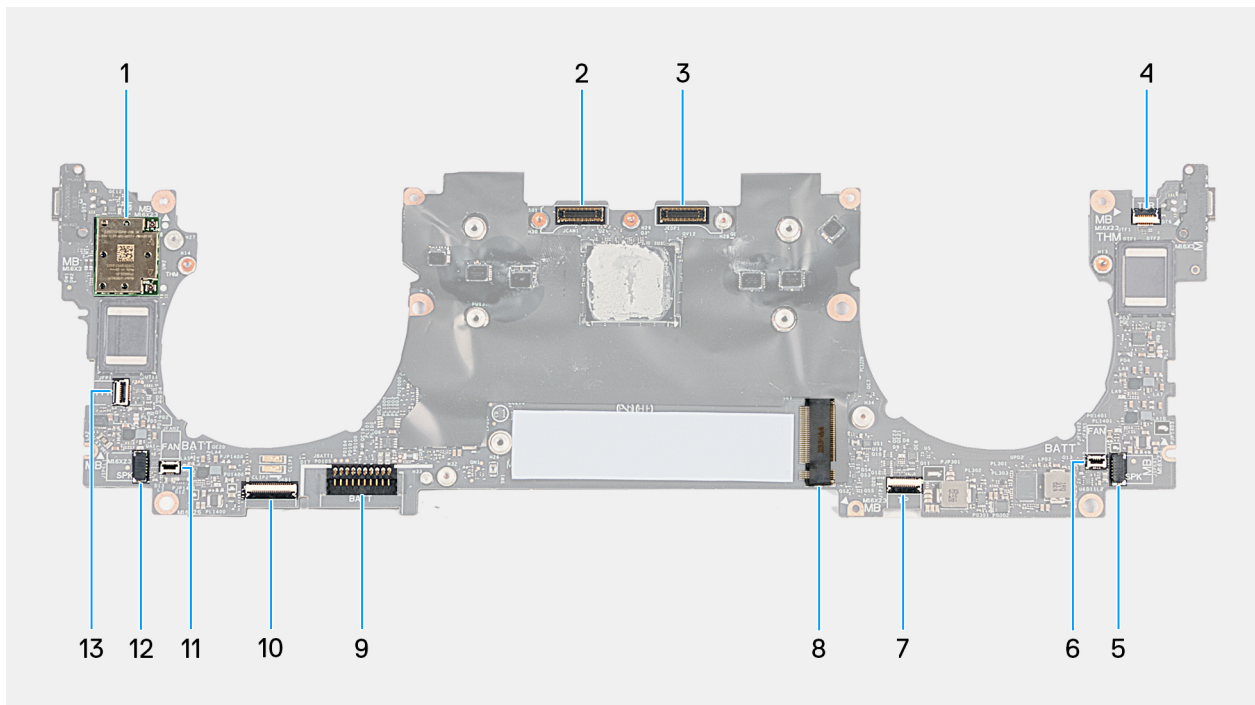

Figure 45. System-board connectors

- | | |
|--|---|
| 1. Wireless card | 2. Camera-assembly cable connector (JCAM1) |
| 3. Display cable connector (JEDP1) | 4. Capacitive touch function row cable connector (JTF1) |
| 5. Left-speaker cable connector (JSPKR1) | 6. Left-fan cable connector (JFAN1) |

- 7. Haptic-module cable connector (JTP1)
- 9. Battery cable connector (JBATT1)
- 11. Right-fan cable connector (JFAN2)
- 13. Power-button connector (JFP1)
- 8. M.2 solid-state drive slot
- 10. Keyboard-control board cable connector (JKB1)
- 12. Right-speaker cable connector (JSPKL1)

The following images indicate the location of the system board and provide a visual representation of the removal procedure.

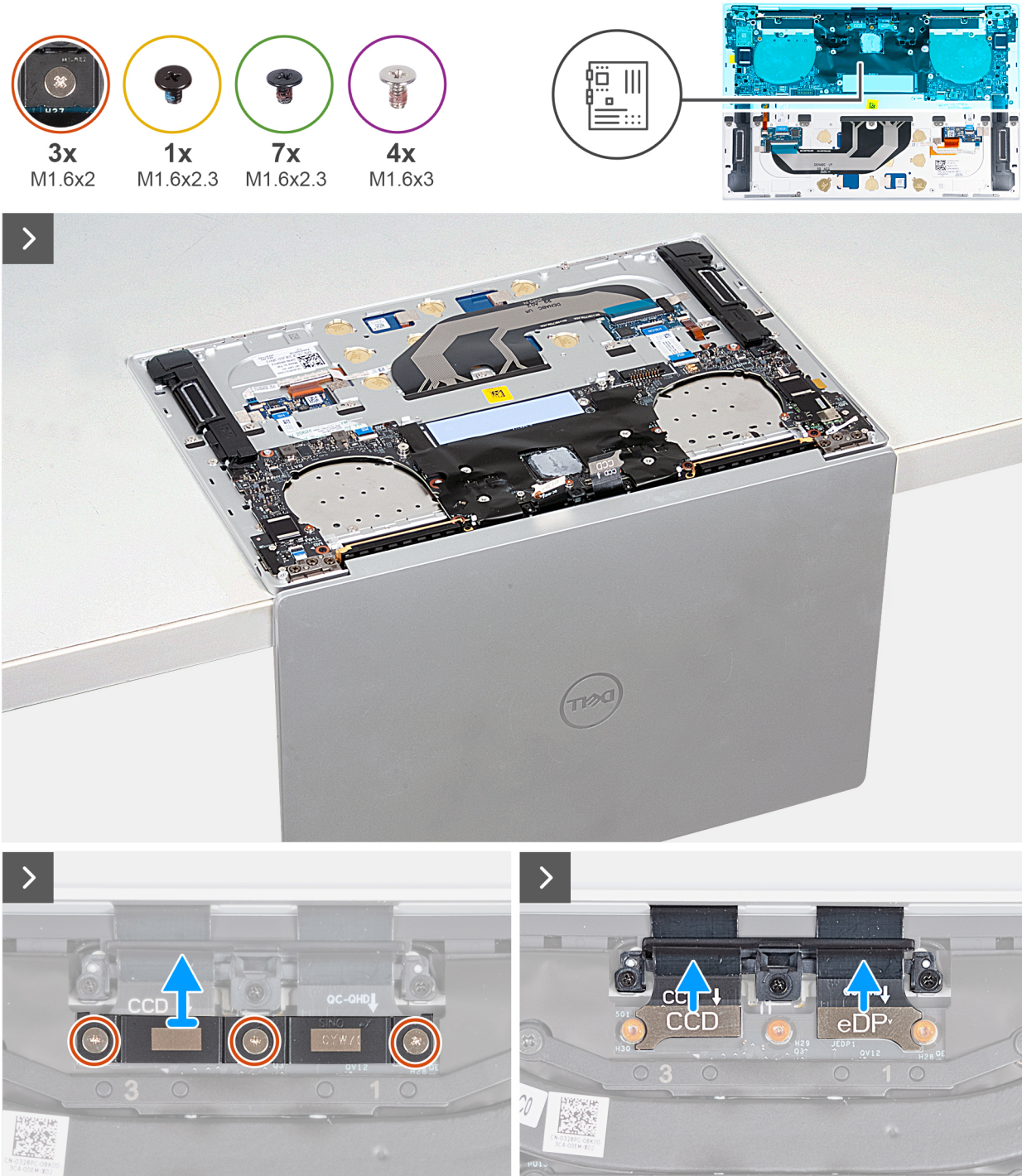

Figure 46. Removing the system board

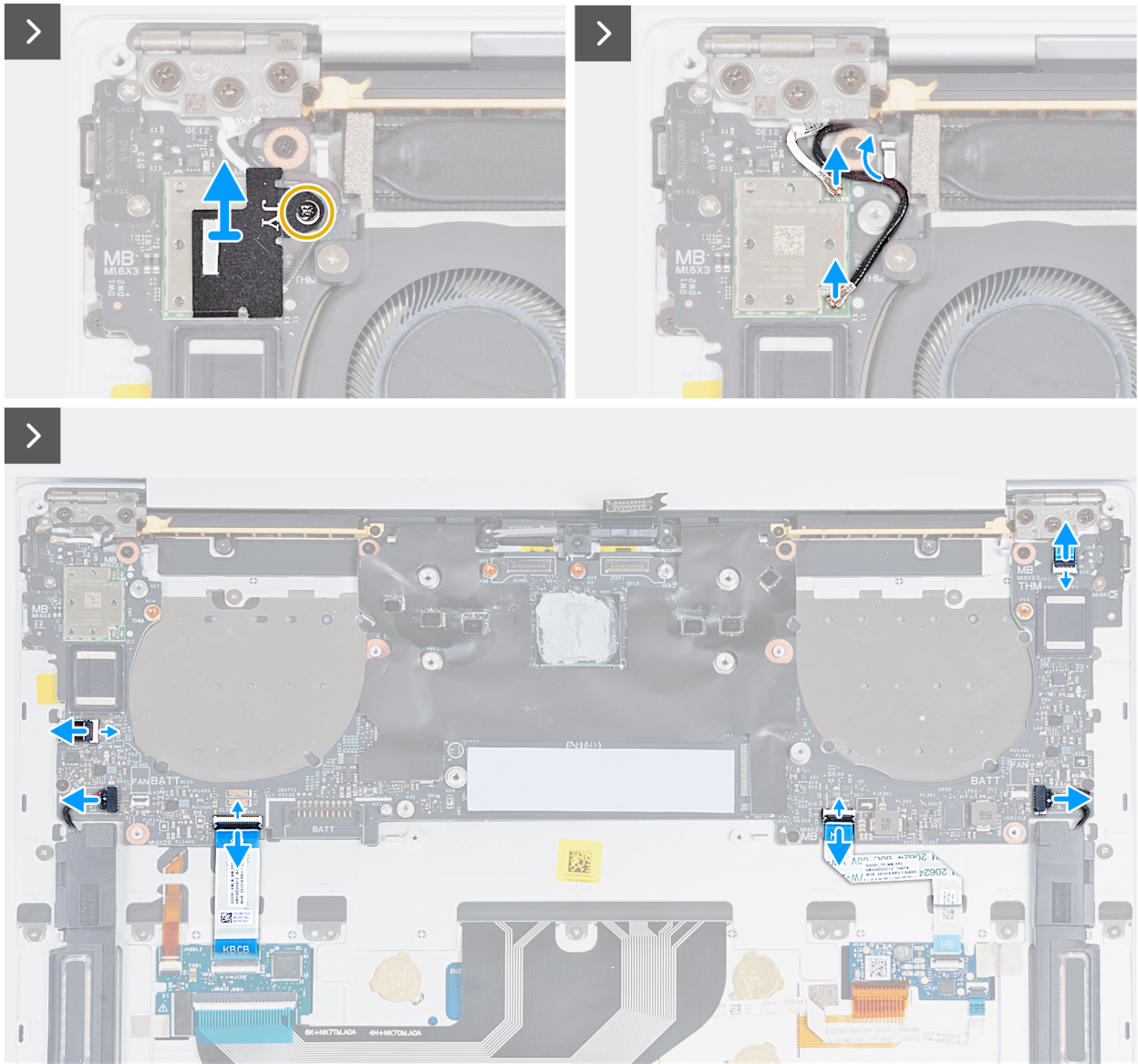

Figure 47. Removing the system board

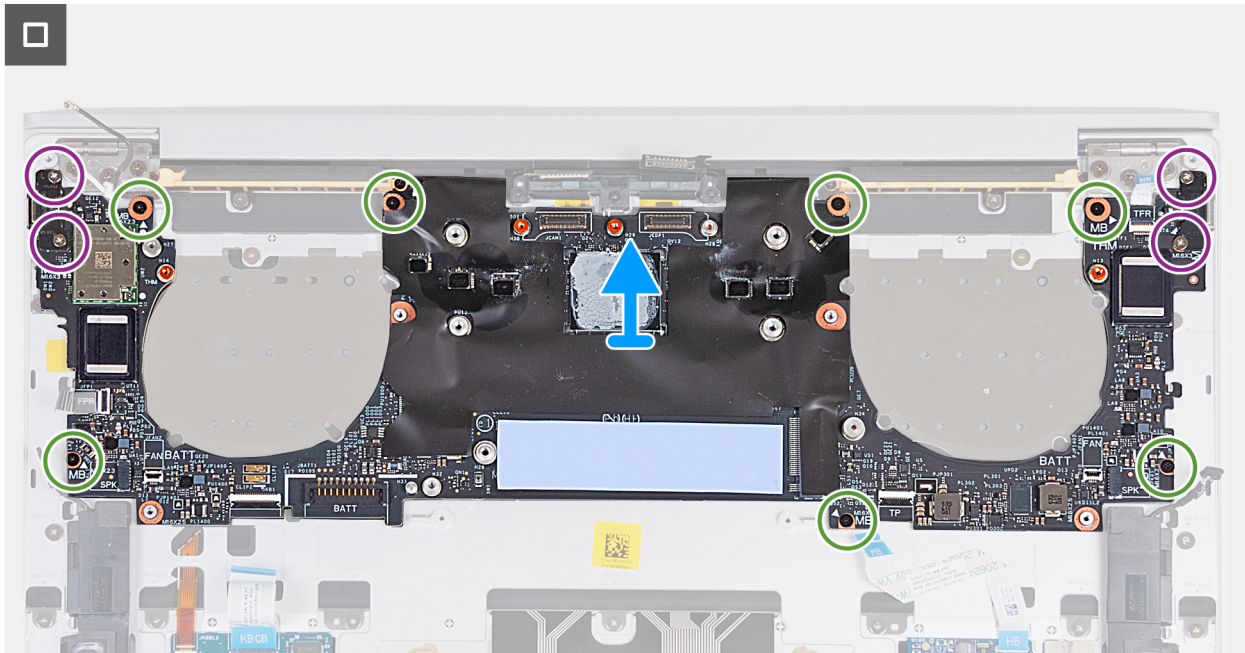

Figure 48. Removing the system board

Steps

1. Open the display assembly to a 90-degree angle and then place the computer on the edge of a flat surface. Ensure to maintain the angle throughout the removal process to minimize the risk of damaging the thin display panel when applying torque to install and remove screws from the computer.
2. Loosen the three captive screws (M1.6x2) that secure the display-assembly cable bracket to the system board.
3. Lift the display cable bracket off the system board.
4. Disconnect the camera cable from the camera cable connector (JCAM1) on the system board.
5. Disconnect the display cable from the display cable connector (JEDP1) on the system board.
6. Loosen the captive screw (M1.6x2.3) that secures the wireless-module bracket to the system board.
 - NOTE:** Be sure that the small, clear washer that holds the captive screw in place does not fall off.
7. Lift the wireless-module bracket off the system board.
8. Disconnect the wireless-module cables from the wireless module.
9. Open the latch of the capacitive touch function row connector and use the pull tab of the cable to disconnect the capacitive touch function row cable (JTF1) from the system board.
10. Use the pull tab to disconnect the left-speaker cable (JSPKR1) from the system board.
11. Open the latch of the haptic-module cable connector and use the pull tab of the cable to disconnect the haptic-module cable (JTP1) from the system board.
12. Open the latch of the keyboard control-board connector and use the pull tab of the cable to disconnect the keyboard control-board cable from the system board.
13. Use the pull tab to disconnect the right-speaker cable from the connector (JSPKL1) from the system board.
14. Lift the latch of the power-button connector and use the pull tab of the cable to disconnect the power-button cable connector (JFP1) on the system board.
15. Remove the four screws (M1.6x3) that secure the system board to the palm-rest and keyboard assembly.
16. Remove the seven screws (M1.6x2.3) that secure the system board to the palm-rest and keyboard assembly.
17. Hold the system board by the edges and lift the board off the palm-rest and keyboard assembly with care.

Installing the system board

CAUTION: The information in this installation section is intended for authorized service technicians only.

Prerequisites

If you are replacing a component, remove the existing component before performing the installation procedure.

About this task

The following image indicates the connectors and components on your system board.

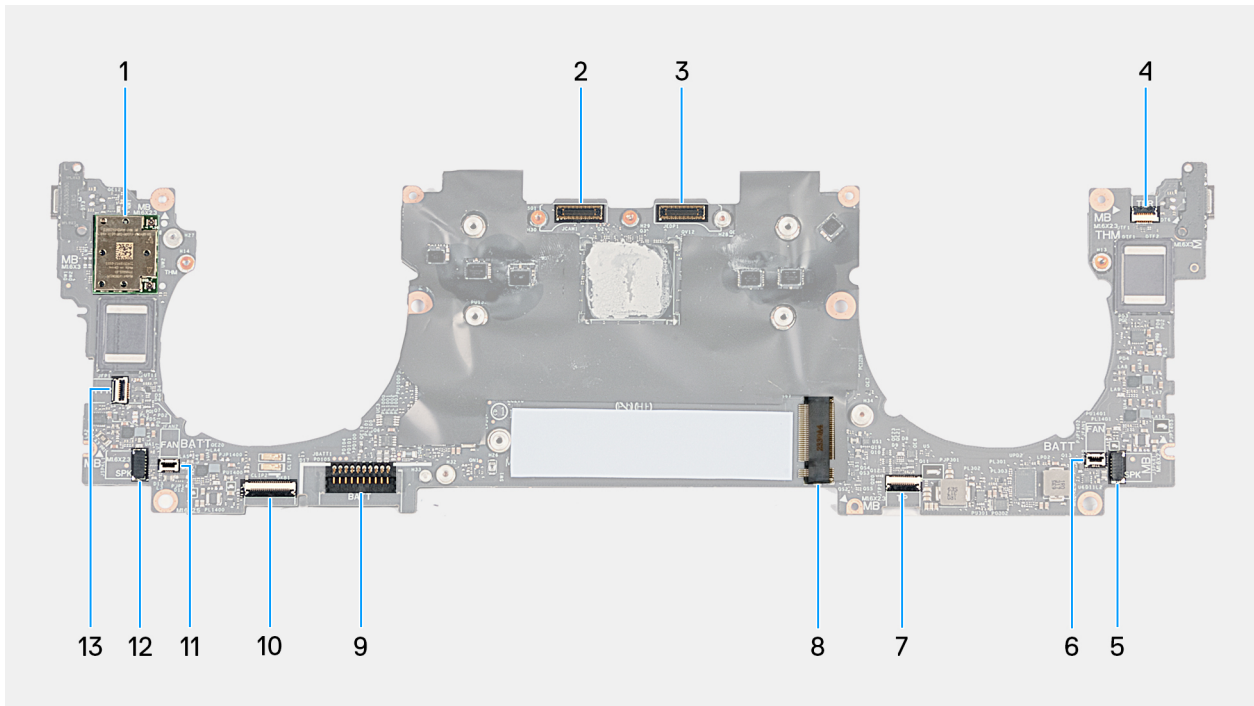

Figure 49. System-board connectors

- | | |
|--|---|
| 1. Wireless card | 2. Camera-assembly cable connector (JCAM1) |
| 3. Display cable connector (JEDP1) | 4. Capacitive touch function row cable connector (JTF1) |
| 5. Left-speaker cable connector (JSPKR1) | 6. Left-fan cable connector (JFAN1) |
| 7. Haptic-module cable connector (JTP1) | 8. M.2 solid-state drive slot |
| 9. Battery cable connector (JBATT1) | 10. Keyboard-control board cable connector (JKB1) |
| 11. Right-fan cable connector (JFAN2) | 12. Right-speaker cable connector (JSPKL1) |
| 13. Power-button connector (JFP1) | |

The following images indicate the location of the system board and provide a visual representation of the installation procedure.

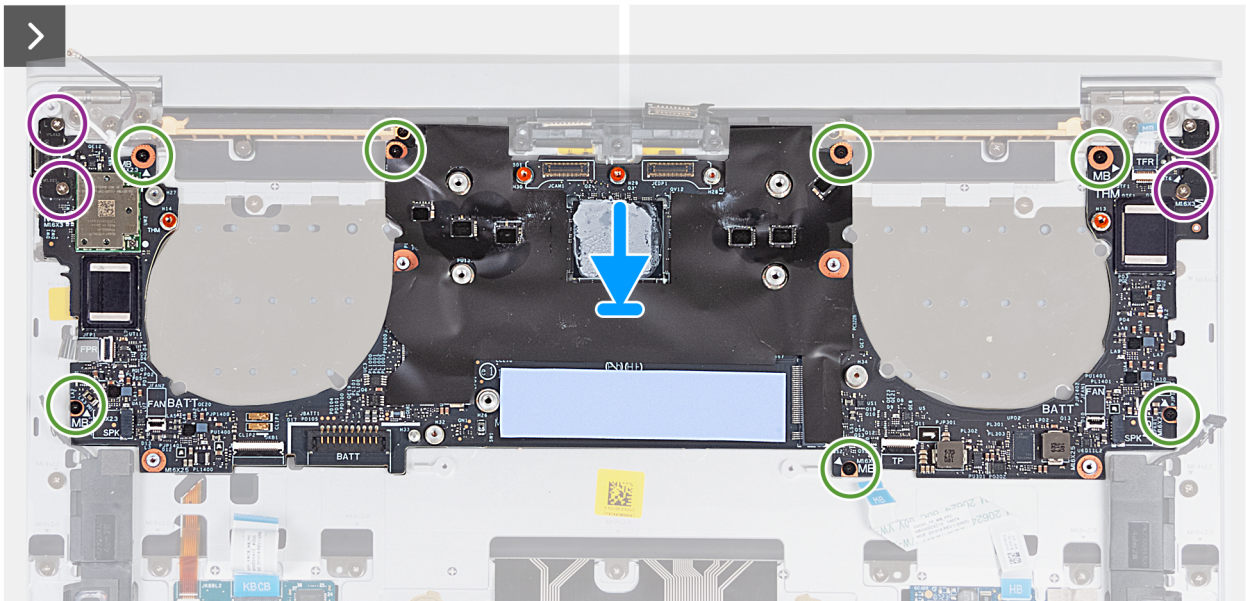
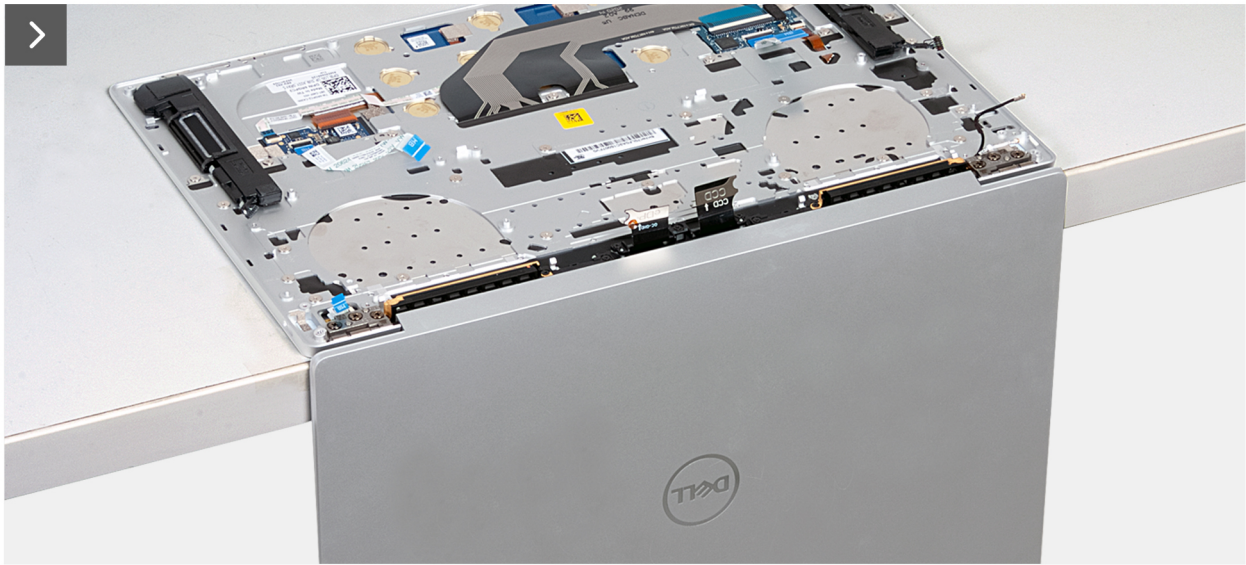

Figure 50. Installing the system board

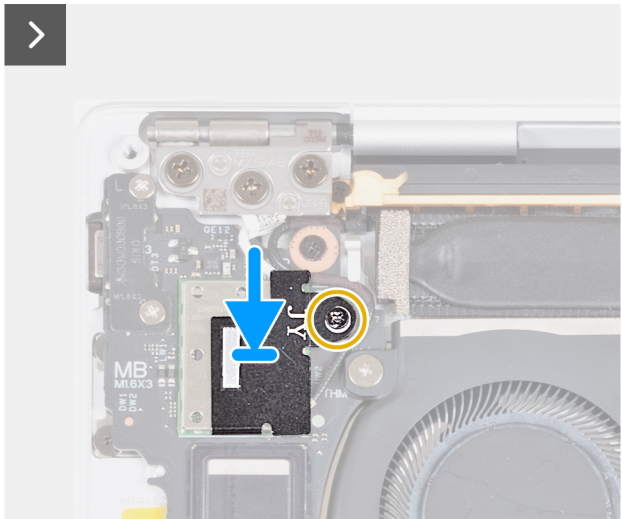
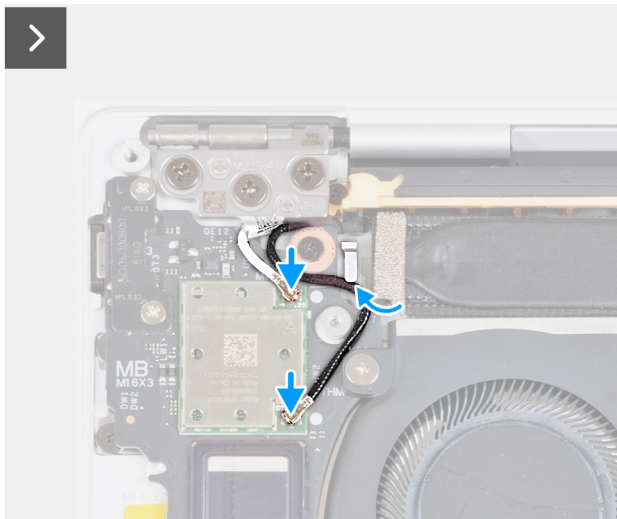
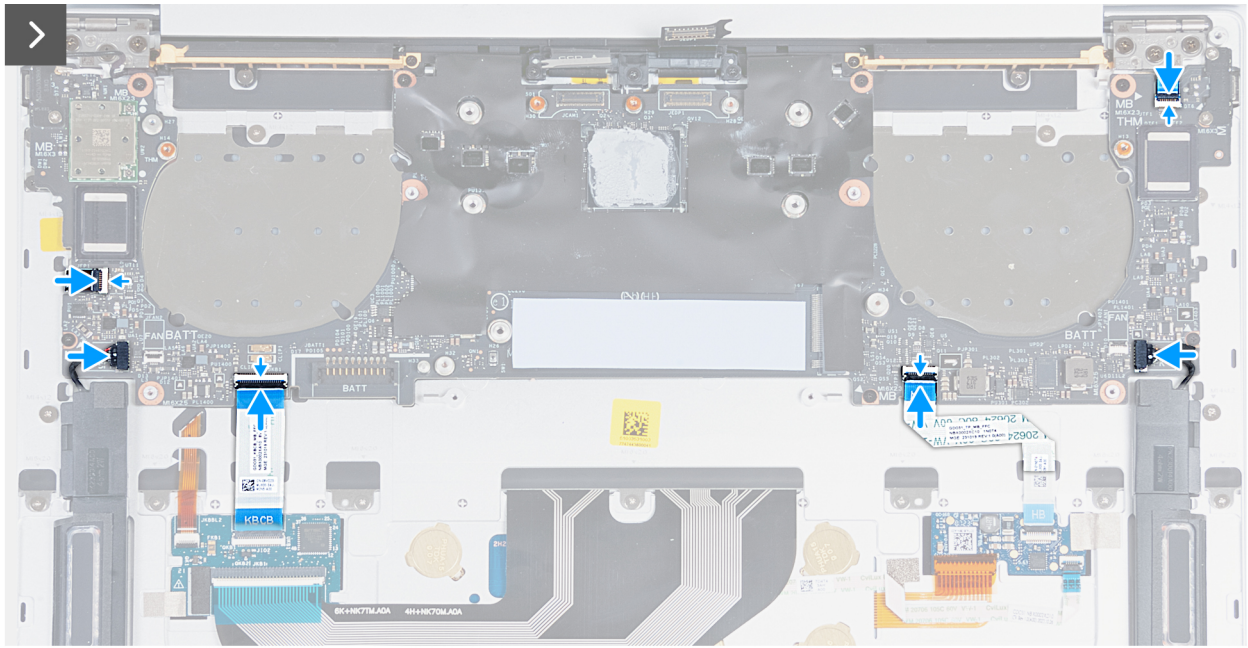

Figure 51. Installing the system board

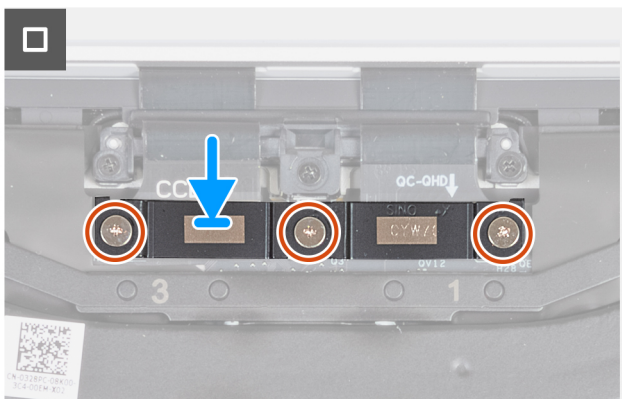
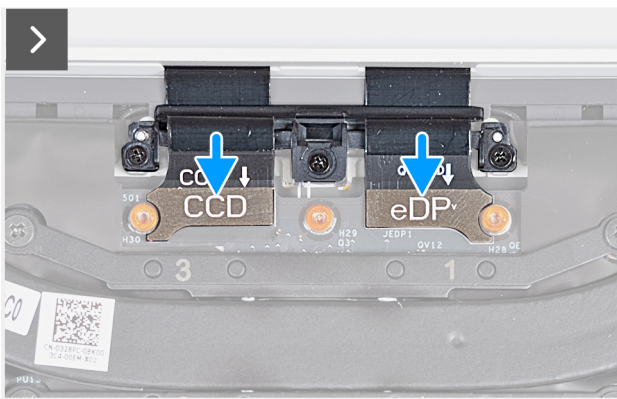



Figure 52. Installing the system board

Steps

1. Open the display assembly to a 90-degree angle and then place the computer on the edge of a flat surface. Ensure to maintain the angle throughout the removal process to minimize the risk of damaging the thin display panel when applying torque to install and remove screws from the computer.
2. Align the screw holes on the system board with the screw holes on the palm-rest and keyboard assembly.
3. Place the system board on the palm-rest and keyboard assembly. Ensure that the USB-C ports are aligned with their corresponding port holes on the palm-rest and keyboard assembly.
4. Replace the seven screws (M1.6x2.3) that secure the system board to the palm-rest and keyboard assembly.
5. Replace the four screws (M1.6x3) that secure the system board to the palm-rest and keyboard assembly.
6. Connect the power-button cable and close the latch of the power-button connector to secure the cable.
7. Connect the right-speaker cable to the connector (JSPKL1) on the system board.
8. Connect the keyboard control-board cable and close the latch of the keyboard control-board connector to secure the cable.
9. Connect the haptic-module cable and close the latch of the haptic-module cable connector (JTP1) to secure the cable.
10. Connect the left-speaker cable to the connector (JSPKR1) on the system board.
11. Connect the capacitive touch function row cable and close the latch of the capacitive touch function row connector (JTF1) on the system board to secure the cable.
12. Connect the wireless-module cables to the wireless module.
13. Replace the wireless-module bracket on the system board.
14. Tighten the captive screw (M1.6x2.3) that secures the wireless-module bracket to the system board.
 **NOTE:** Be sure that the small, clear washer that holds the captive screw is in place before tightening the screw.
15. Connect the camera cable to the camera cable connector (JCAM1) on the system board.
16. Connect the display cable to the display cable connector (JEDP1) on the system board.
17. Replace the display-assembly cable bracket on the system board.
18. Tighten the three captive screws (M1.6x2) that secure the display-assembly cable bracket to the system board.

Next steps

1. Install the [heat sink](#).
2. Install the [fans](#).
3. Install the [battery](#).
4. Install the [M.2 2230 solid-state drive](#) or [M.2 2280 solid-state drive](#) from M.2 slot, whichever is applicable.
5. Install the [base cover](#).
6. Follow the procedure in [After working inside your computer](#).

Power button with fingerprint reader

Removing the power button with fingerprint reader

 **CAUTION:** The information in this removal section is intended for authorized service technicians only.

Prerequisites

1. Follow the procedure in [Before working in your computer](#).
2. Remove the [base cover](#).
3. Remove the [battery](#).
4. Remove the [system board](#).

 **NOTE:** The system board can be removed with the following components attached:

- Heat sink
- Fans

 **NOTE:** The two screws (M1.6x2.5) that secure the fans to the palm rest must be removed first.

- Solid state drive

About this task

The following images indicate the location of the power button with fingerprint reader and provide a visual representation of the removal procedure.

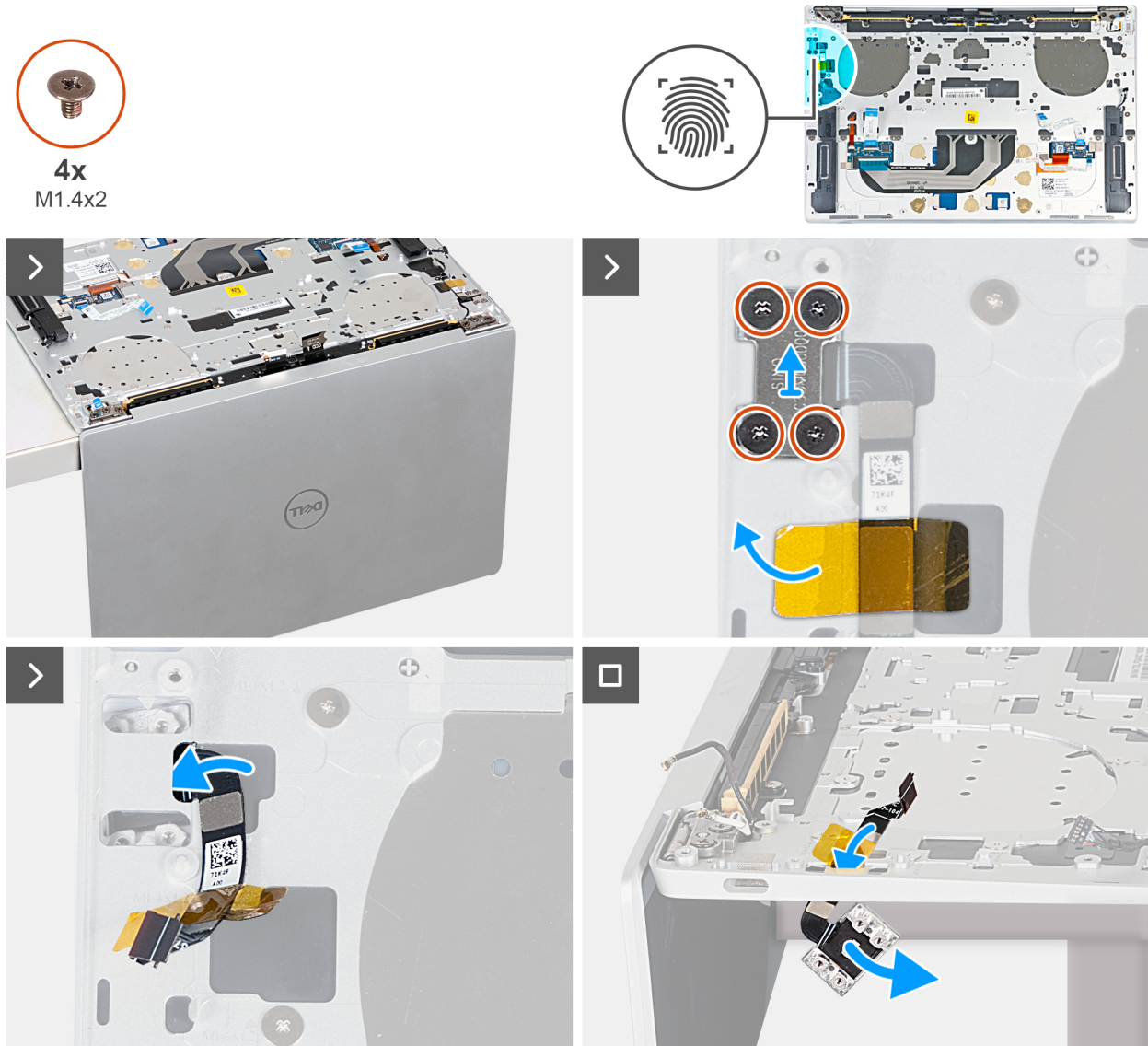

Figure 53. Removing the power button with fingerprint reader

Steps

1. Open the display assembly to a 90-degree angle and place the computer on the edge of a flat surface. Ensure to maintain the angle throughout the removal process to minimize the risk of damaging the thin display panel when applying torque to install and remove screws from the computer.
2. Remove the four screws (M1.4x2) that secure the power-button bracket to the palm-rest and keyboard assembly.
3. Lift the power-button bracket off the palm-rest and keyboard assembly.
4. Lift the palm-rest and keyboard assembly slightly.
5. Unthread the power-button cable through the opening on the upper-left side of the palm-rest and keyboard assembly and remove the power button with fingerprint reader.

Installing the power button with a fingerprint reader

CAUTION: The information in this installation section is intended for authorized service technicians only.

Prerequisites

If you are replacing a component, remove the existing component before performing the installation process.

About this task

The following images indicate the location of the power button with fingerprint reader and provide a visual representation of the installation procedure.

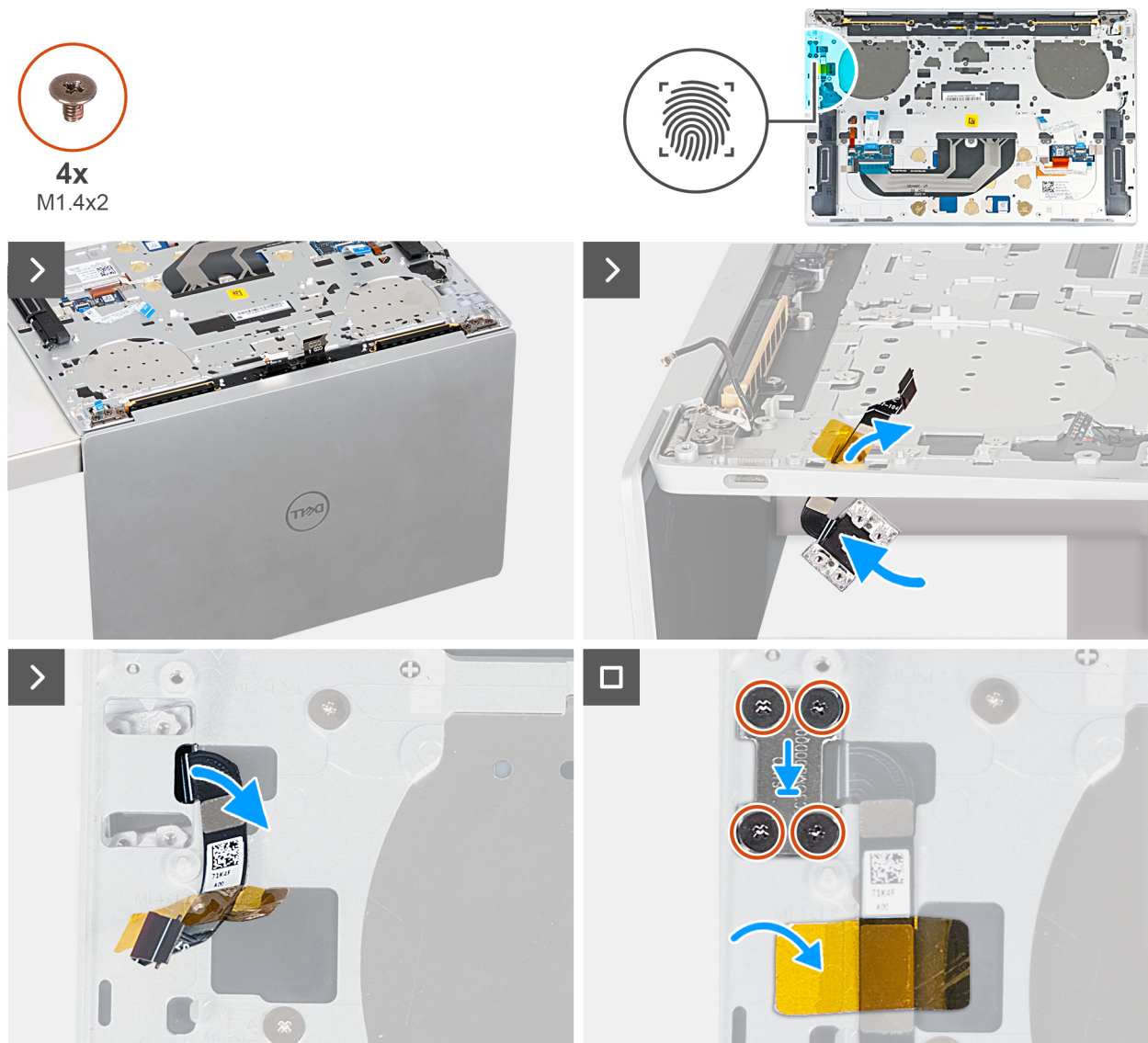

Figure 54. Installing the power button with fingerprint reader

Steps

1. Open the display assembly to a 90-degree angle and place the computer on the edge of a flat surface. Ensure to maintain the angle throughout the installation process to minimize the risk of damaging the thin display panel when applying torque to install and remove screws from the computer.
2. Thread the power-button cable through the opening on the upper-left side of the palm-rest and keyboard assembly.
3. Place the power button with fingerprint reader on the palm-rest and keyboard assembly.

4. Align the screw holes of the power button with the screw holes of the power-button bracket.
5. Replace the four screws (M1.4x2) that secure the power-button bracket to the palm-rest and keyboard assembly.

Next steps

1. Install the [system board](#).

i **NOTE:** The system board can be replaced with the following components attached:

- Heat sink
- Fans

i **NOTE:** Also replace the two screws (M1.6x2.5) that secure the fans to the palm rest.

- Solid state drive

2. Install the [battery](#).
3. Install the [base cover](#).
4. Follow the procedure in [After working inside your computer](#).

Keyboard

Removing the keyboard

⚠ CAUTION: The information in this removal section is intended for authorized service technicians only.

Prerequisites

1. Follow the procedure in [Before working in your computer](#).
2. Remove the [base cover](#).
3. Remove the [battery](#).
4. Remove the [system board](#).

i **NOTE:** The system board can be removed with the following components attached:

- heat sink
- fans

i **NOTE:** The two screws (M1.6x2.5) that secure the fans to the palm rest must be removed first.

- solid-state drive

5. Remove the [power button with fingerprint reader](#).

About this task

The following images indicate the location of the keyboard and provide a visual representation of the removal procedure.



17x
M1.4x1.2



7x
M1.6x2

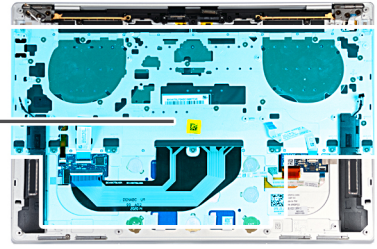

Figure 55. Removing the keyboard

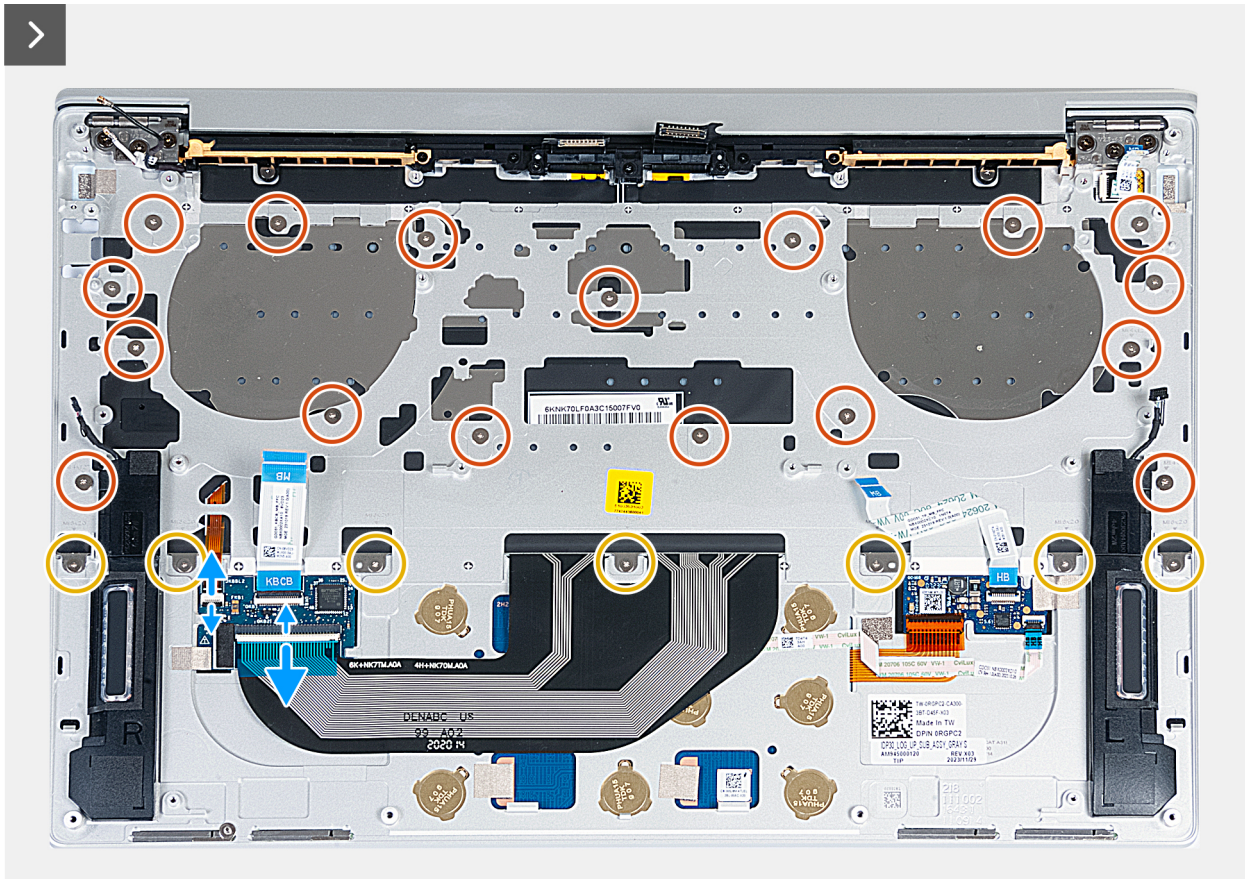

Figure 56. Removing the keyboard

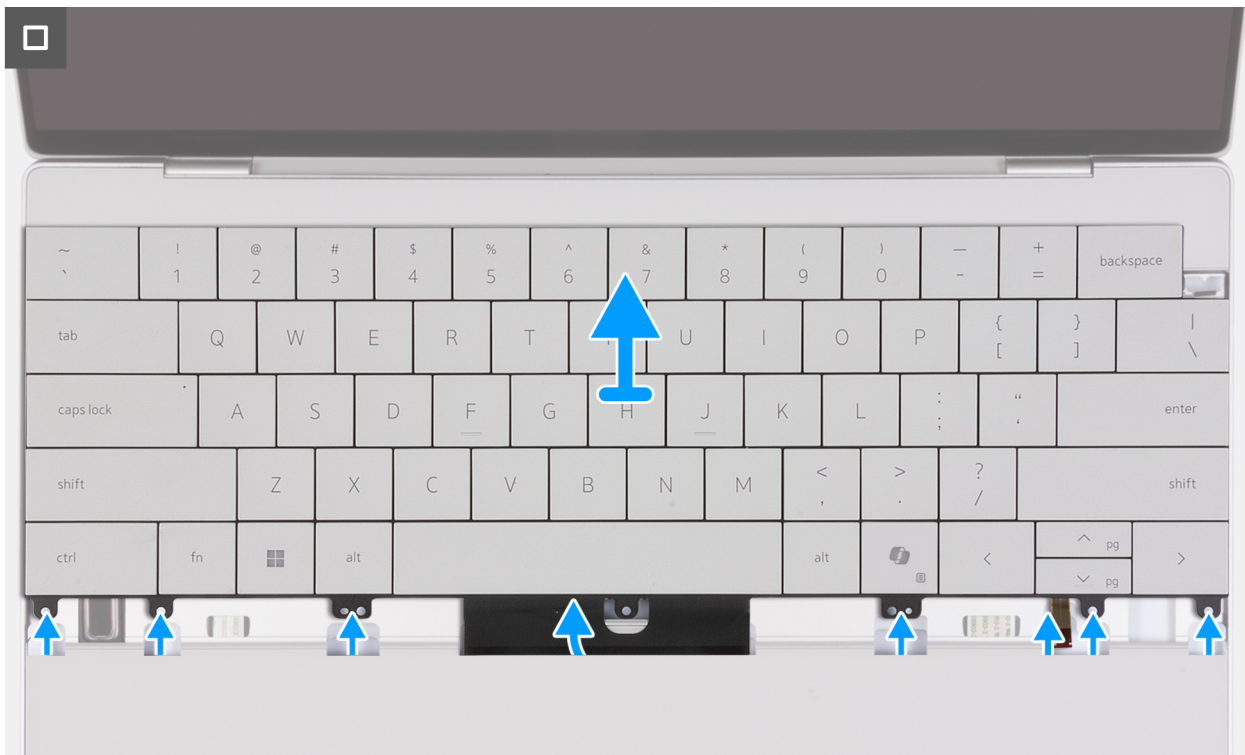

Figure 57. Removing the keyboard

Steps

1. Open the display assembly to a 90-degree angle and place the computer on the edge of a flat surface. Ensure to maintain the angle throughout the removal process to minimize the risk of damaging the thin display panel when applying torque to install and remove screws from the computer.
2. Remove the 17 screws (M1.4x1.2) that secure the keyboard to the palm-rest assembly.
3. Remove the seven screws (M1.6x2) that secure the keyboard to the palm-rest assembly.
4. Lift the latch of the keyboard-backlight connector and use the pull tab of the cable to disconnect the keyboard-backlight cable from the connector on the keyboard-control daughterboard.
5. Lift the latch of the keyboard connector and use the pull tab of the cable to disconnect the keyboard cable from the from the connector on the keyboard-control daughterboard.
6. Unthread the keyboard-backlight cable and the keyboard cable through the openings of the palm-rest assembly.
7. Lift the keyboard off the palm-rest assembly until the tabs of the keyboard are out from the openings on the palm-rest assembly.

Installing the keyboard

 **CAUTION: The information in this installation section is intended for authorized service technicians only.**

Prerequisites

If you are replacing a component, remove the existing component before performing the installation process.

About this task

The following images indicate the location of the keyboard and provide a visual representation of the installation procedure.



17x
M1.4x1.2



7x
M1.6x2

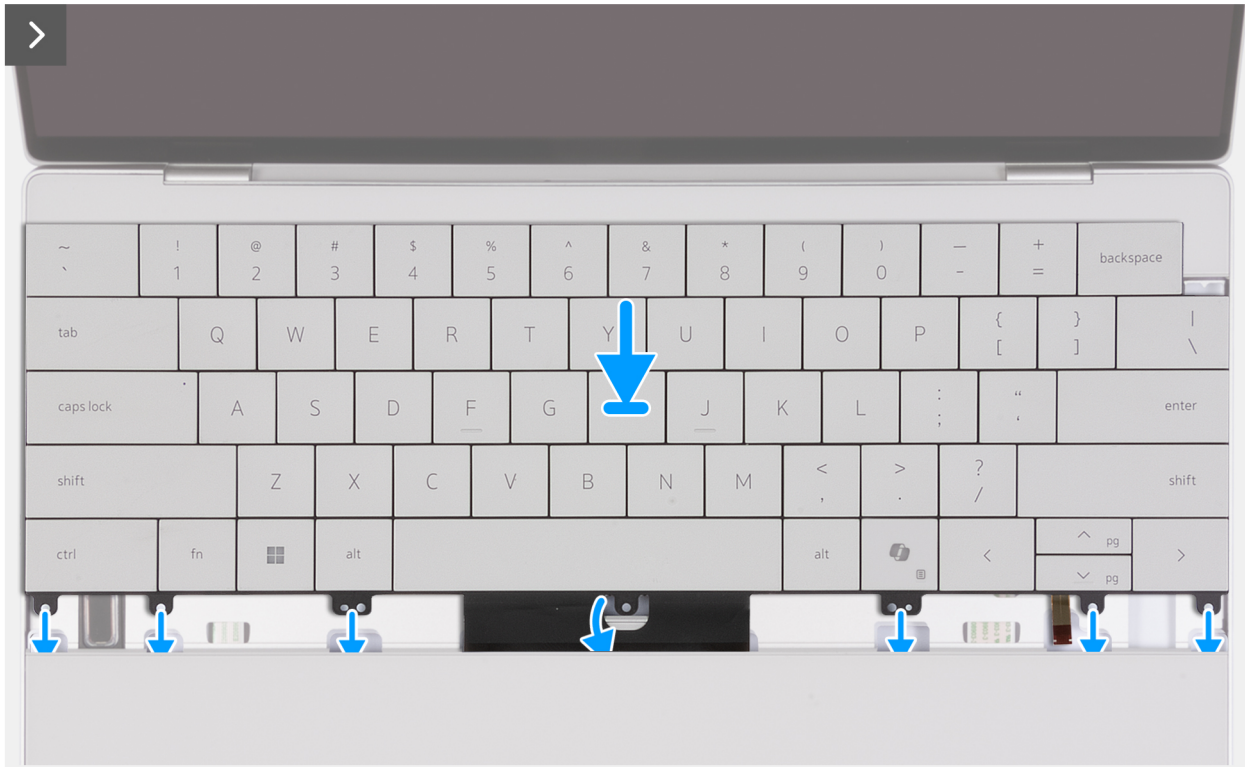
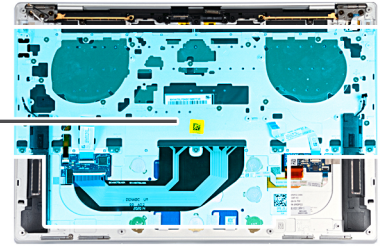

Figure 58. Installing the keyboard



Figure 59. Installing the keyboard

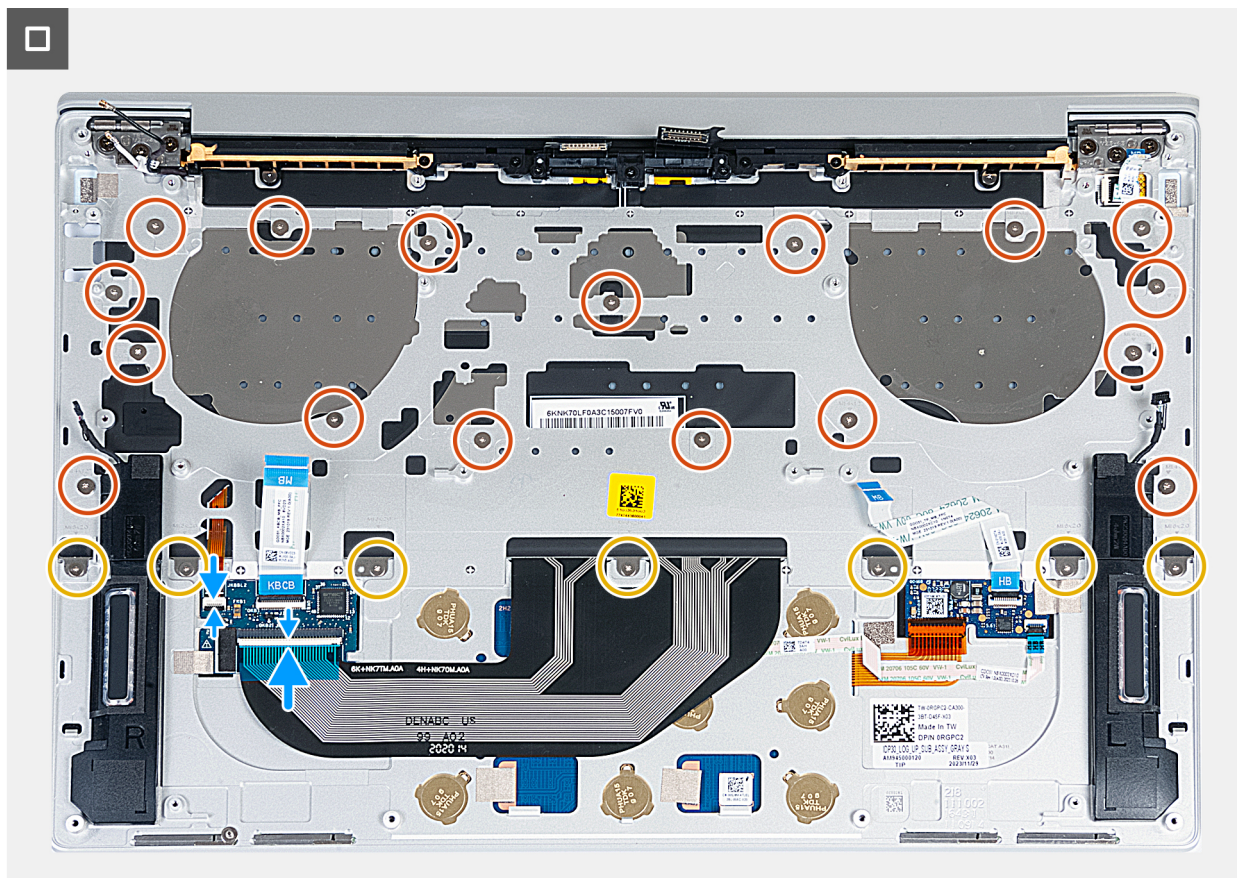

Figure 60. Installing the keyboard

Steps

1. Open the display assembly to a 90-degree angle and place the computer on the edge of a flat surface. Ensure to maintain the angle throughout the removal process to minimize the risk of damaging the thin display panel when applying torque to install and remove screws from the computer.
2. Align the screw holes of the keyboard with the screw holes of the palm-rest assembly.
3. Thread the keyboard-backlight cable and the keyboard cable through the openings at the center and right side of the palm rest and insert the tabs on the keyboard into the openings on the palm rest.
4. Replace the seven screws (M1.6x2) to secure the keyboard to the palm-rest assembly.
5. Replace the 17 screws (M1.4x1.2) to secure the keyboard to the palm-rest assembly.
6. Connect the keyboard-backlight cable to the connector on the keyboard-control daughterboard and close the latch.
7. Connect the keyboard cable to the connector on the keyboard-control daughterboard and close the latch.

Next steps

1. Install the [power button with fingerprint reader](#).
2. Install the [system board](#).

i NOTE: The system board can be replaced with the following components attached:

- heat sink
- fans

i NOTE: Also replace the two screws (M1.6x2.5) that secure the fans to the palm rest.

- solid-state drive

3. Install the [battery](#).
4. Install the [base cover](#).

5. Follow the procedure in [After working inside your computer](#).

Palm-rest assembly

Removing the palm-rest assembly

 **CAUTION:** The information in this removal section is intended for authorized service technicians only.

Prerequisites

1. Follow the procedure in [Before working in your computer](#).
2. Remove the [base cover](#).
3. Remove the [battery](#).
4. Remove the [display assembly](#).
5. Remove the [system board](#).

 **NOTE:** The system board can be removed with the following components attached:

- Heat sink
- Fans

 **NOTE:** The two screws (M1.6x2.5) that secure the fans to the palm rest must be removed first.

- Solid state drive

6. Remove the [power button with fingerprint reader](#).
7. Remove the [keyboard](#).

About this task

The following images indicate the location of the palm-rest assembly and provide a visual representation of the removal procedure.

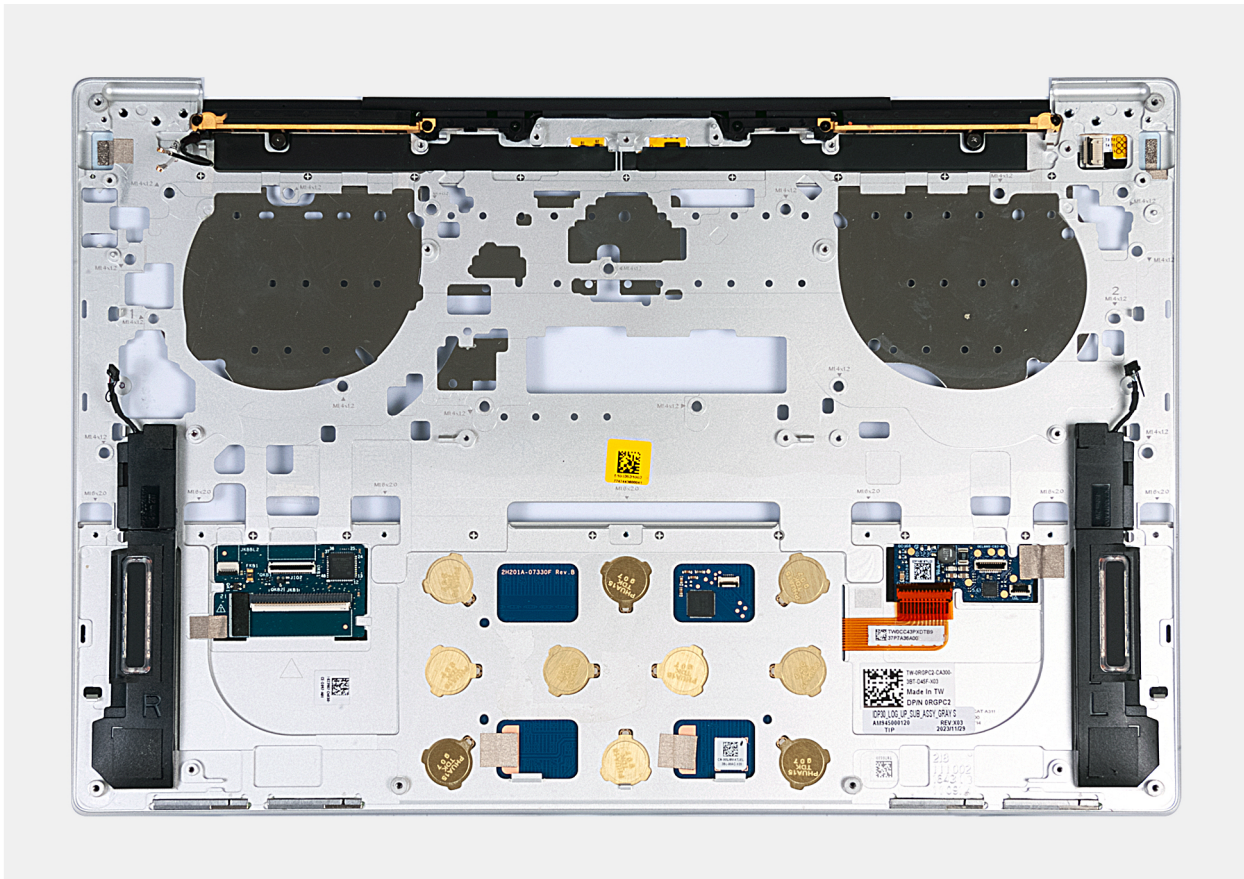

Figure 61. Removing the palm-rest assembly

Steps

After performing the steps in the pre-requisites, you are left with the palm-rest assembly.

i NOTE: Depending on the configuration ordered, the palm-rest assembly may appear visually different. The palm-rest assemblies are interchangeable though, and connected to components using the same cables and connectors.

Installing the palm-rest assembly

⚠ CAUTION: The information in this installation section is intended for authorized service technicians only.

Prerequisites

If you are replacing a component, remove the existing component before performing the installation process.

About this task

i NOTE: The replacement palm-rest assembly comes preassembled with the following components:

- Palm rest
- Speakers
- Wireless-antenna modules
- Touchpad
- Haptic module
- keyboard-control daughterboard

The following images indicate the location of the palm-rest assembly and provide a visual representation of the installation procedure.

NOTE: Depending on the configuration ordered, the palm-rest assembly may appear visually different. The palm-rest assemblies are interchangeable though, and connected to components using the same cables and connectors.

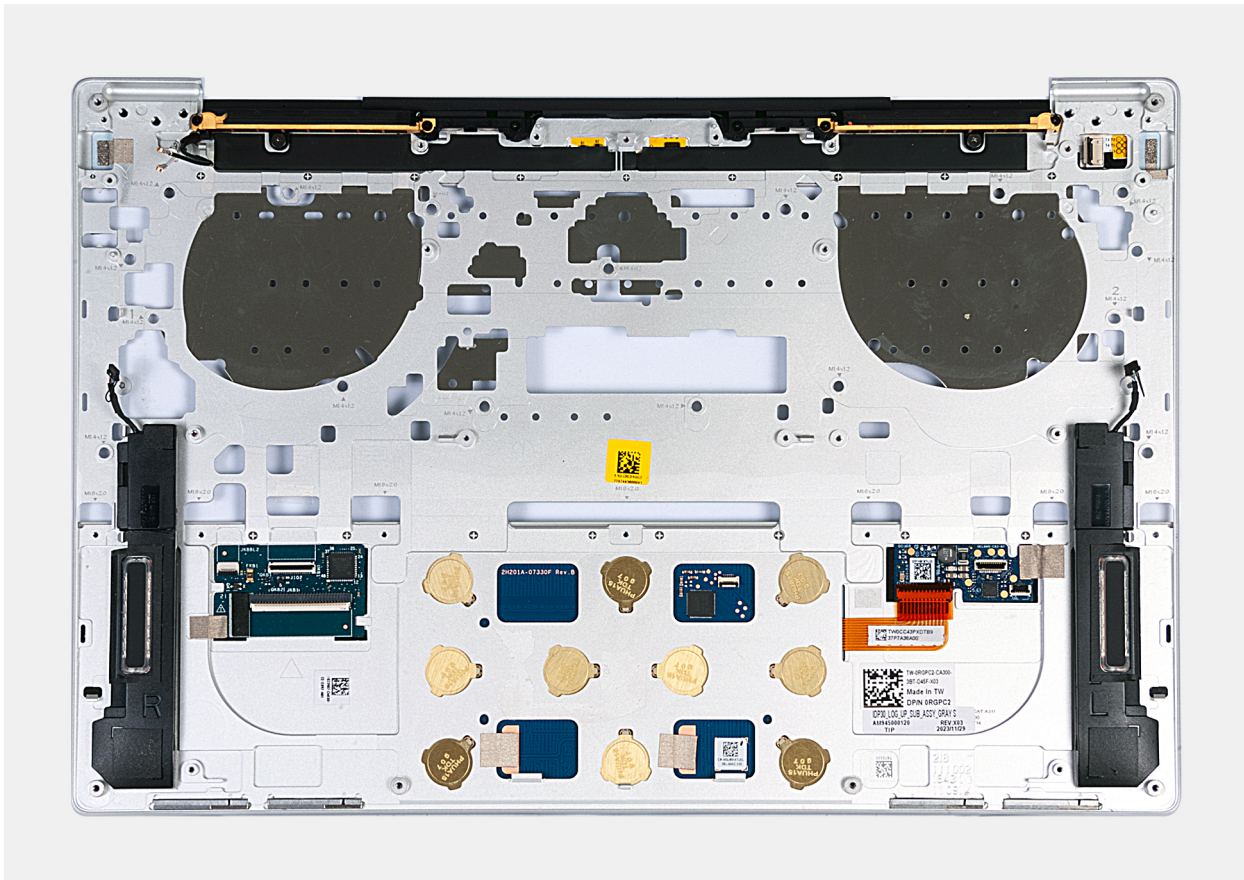

Figure 62. Installing the palm-rest assembly

Steps

Place the palm-rest assembly on a flat surface.

Next steps

1. Install the [keyboard](#).
2. Install the [power button with fingerprint reader](#).
3. Install the [system board](#).

NOTE: The system board can be replaced with the following components preattached:

- Heat sink
- Fans

NOTE: Also replace the two screws (M1.6x2.5) that secure the fans to the palm rest.

- Solid state drive

4. Install the [display assembly](#).
5. Install the [battery](#).
6. Install the [base cover](#).
7. Follow the procedure in [After working inside your computer](#).

Software

This chapter details the supported operating systems along with instructions on how to install the drivers.

Operating system

Your XPS 13 9345 supports the following operating systems:

- Windows 11 Home, ARM
- Windows 11 Pro, ARM

Drivers and downloads

When troubleshooting, downloading, or installing drivers, it is recommended that you read the Dell Knowledge Base article [Drivers and Downloads FAQs 000123347](#).

BIOS Setup

CAUTION: Certain changes can make your computer work incorrectly. Before you change the settings in BIOS Setup, it is recommended that you note down the original settings for future reference.

NOTE: Depending on the computer and the installed devices, the options that are listed in this section may differ.

Use BIOS Setup for the following purposes:

- Get information about the hardware installed in your computer, such as the amount of RAM and the capacity of the storage device.
- Change the system configuration information.
- Set or change user-selectable options such as the user password, enabling or disabling base devices, and configuring hard drive settings.

Entering BIOS Setup program

About this task

Turn on (or restart) your computer and press F2 immediately.

Navigation keys

NOTE: For most of the BIOS Setup options, changes that you make are recorded but do not take effect until you restart the computer.

Table 24. Navigation keys

Keys	Navigation
Up arrow	Moves to the previous field.
Down arrow	Moves to the next field.
Enter	Selects a value in the selected field (if applicable) or follows the link in the field.
Spacebar	Expands or collapses a drop-down list, if applicable.
Tab	Moves to the next focus area.
Esc	Moves to the previous page until you view the main screen. Pressing Esc in the main screen displays a message that prompts you to save any unsaved changes and restart the computer.

F12 One Time Boot menu

To enter the One Time Boot menu, turn on or restart your computer, and then press F12 immediately.

NOTE: If you are unable to enter the One Time Boot menu, repeat the above action.

The One Time Boot menu displays the devices that you can boot from and also display the options to start diagnostics. The boot menu options are:

- Removable Drive (if available)

- STXXXX Drive (if available)

NOTE: XXX denotes the SATA drive number.

- Optical Drive (if available)
- SATA Hard Drive (if available)
- Diagnostics

The One Time Boot menu screen also displays the option to access BIOS Setup.

View Advanced Setup options

About this task

Some BIOS Setup options are only visible by enabling **Advanced Setup** mode.

NOTE: BIOS Setup options, including **Advanced Setup** options, are described in [System Setup options](#). By default, **Advanced Setup** options are visible.

To enable Advanced Setup

Steps

1. Enter BIOS Setup.
The Overview menu appears.
2. Click the **Advanced Setup** option to move it to the **ON** mode.
The Advanced BIOS Setup options are visible.

System Setup options

NOTE: For most of the System Setup options, changes that you make are recorded but do not take effect until you restart the computer.

NOTE: Depending on your computer and its installed devices, the items that are listed in this section may differ.

Table 25. System Setup options—Overview menu

Overview	
XPS 13 9345	
BIOS Version	Displays the BIOS version number.
Service Tag	Displays the Service Tag of the computer.
Asset Tag	Displays the Asset Tag of the computer.
Manufacture Date	Displays the manufacture date of the computer.
Ownership Date	Displays the ownership date of the computer.
Express Service Code	Displays the Express Service Code of the computer.
Ownership Tag	Displays the Ownership Tag of the computer.
Signed Firmware Update	Displays whether the Signed Firmware Update is enabled on your computer. By default, the Signed Firmware Update option is enabled.
BATTERY	
Primary	Displays the primary battery of the computer.
Battery Level	Displays the battery level of the computer.
Battery State	Displays the battery state of the computer.

Table 25. System Setup options—Overview menu (continued)

Overview	
Health	Displays the battery health of the computer.
AC Adapter	Displays whether an AC adapter is connected. If connected, displays the type of AC adapter that is connected.
PROCESSOR	
Processor Type	Displays the processor type.
Maximum Clock Speed	Displays the maximum processor clock speed. i NOTE: To view this option, enable Advanced Setup mode as described in View Advanced Setup options .
Minimum Clock Speed	Displays the minimum processor clock speed. i NOTE: To view this option, enable Advanced Setup mode as described in View Advanced Setup options .
Current Clock Speed	Displays the current processor clock speed. i NOTE: To view this option, enable Advanced Setup mode as described in View Advanced Setup options .
Core Count	Displays the number of cores on the processor.
Processor L2 cache	Displays the processor L2 cache. i NOTE: To view this option, enable Advanced Setup mode as described in View Advanced Setup options .
64-Bit Technology	Displays whether 64-bit technology is enabled. i NOTE: To view this option, enable Advanced Setup mode as described in View Advanced Setup options .
MEMORY	
Memory Installed	Displays the total computer memory installed.
Memory Available	Displays the total computer memory available.
Memory Speed	Displays the memory speed. i NOTE: To view this option, enable Advanced Setup mode as described in View Advanced Setup options .
Memory Channel Mode	Displays single or dual channel mode. i NOTE: To view this option, enable Advanced Setup mode as described in View Advanced Setup options .
Memory Technology	Displays the technology that is used for the memory.
DEVICES	
Panel Type	Displays the panel type of the computer.
Video Controller	Displays the video controller type of the computer.
Wi-Fi Device	Displays the wireless device information of the computer.
Native Resolution	Displays the native resolution of the computer.
Audio Controller	Displays the audio controller information of the computer.
Bluetooth Device	Displays the Bluetooth device information of the computer.
Pass Through MAC Address	Displays the MAC address of the video pass-through.

Table 26. System Setup options—Boot Configuration menu

Boot Configuration	
Boot Sequence	
Boot Mode: UEFI only	Displays the boot mode of the computer.
Enable PXE Boot Priority	When enabled, if a new PXE boot option is detected, it will be added to the top of the Boot Sequence.
Secure Boot	
	Secure Boot is a method of guaranteeing the integrity of the boot path by performing additional validation of the operating system and PCI add-in cards. The computer stops booting to the operating system when a component is not authenticated during the boot process. Secure Boot can be enabled in BIOS setup or using management interfaces like Dell Command Configure, but can only be disabled from BIOS setup.
Enable Secure Boot	<p>Enables the computer to boot using only validated boot software.</p> <p>By default, this Enable Secure Boot option is disabled. For additional security, Dell Technologies recommends keeping the Secure Boot option enabled to ensure that the UEFI firmware validates the operating system during the boot process.</p> <p>i NOTE: To view this option, enable Advanced Setup mode as described in View Advanced Setup options.</p> <p>i NOTE: To enable Secure Boot, the computer is required to be in UEFI boot mode and the Enable Legacy Option ROMs option is required to be turned off.</p>
Enable Microsoft UEFI CA	<p>When disabled, the UEFI CA is removed from the BIOS UEFI Secure Boot database.</p> <p>i NOTE: When disabled, the Microsoft UEFI CA could render your computer unable to boot, computer graphics may not function, some devices may not function properly, and the computer could become unrecoverable.</p> <p>By default, the Enable Microsoft UEFI CA option is enabled.</p> <p>For additional security, Dell Technologies recommends keeping the Microsoft UEFI CA option enabled to ensure the broadest compatibility with devices and operating systems.</p>
Secure Boot Mode	<p>Enables or disables the Secure Boot operation mode.</p> <p>By default, the Deployed Mode is selected. Deployed Mode should be selected for normal operation of Secure Boot.</p> <p>i NOTE: To view this option, enable Advanced Setup mode as described in View Advanced Setup options.</p>
Expert Key Management	
Enable Custom Mode	<p>Enables or disables the keys in the PK, KEK, db, and dbx security key databases to be modified.</p> <p>By default, the Enable Custom Mode option is disabled.</p> <p>i NOTE: To view this option, enable Advanced Setup mode as described in View Advanced Setup options.</p>
Custom Mode Key Management	<p>Selects the custom values for expert key management.</p> <p>By default, the PK option is selected.</p> <p>i NOTE: To view this option, enable Advanced Setup mode as described in View Advanced Setup options.</p>

Table 27. System Setup options—Integrated Devices menu

Integrated Devices	
Camera	
Enable Camera	<p>Enables the camera.</p> <p>By default, the Enable Camera option is enabled.</p> <p>i NOTE: Depending on the configuration ordered, the camera setup option may not be available.</p>
Audio	
Enable Audio	<p>Enables all integrated audio controller.</p> <p>By default, all the options are enabled.</p>
Enable Microphone	<p>Enables the microphone.</p> <p>By default, the Enable Microphone option is enabled.</p> <p>i NOTE: Depending on the configuration ordered, the microphone setup option may not be available.</p>
Enable Internal Speaker	<p>Enables the internal speaker.</p> <p>By default, the Enable Internal Speaker option is enabled.</p>
USB/Thunderbolt Configuration	
Enable External USB Ports	<p>Enables the external USB ports.</p> <p>By default, the Enable External USB Ports option is enabled.</p> <p>i NOTE: To view this option, enable Advanced Setup mode as described in View Advanced Setup options.</p>
Enable USB Boot Support	<p>Enables booting from USB mass storage devices that are connected to external USB ports.</p> <p>By default, the Enable USB Boot Support option is enabled.</p> <p>i NOTE: To view this option, enable Advanced Setup mode as described in View Advanced Setup options.</p>
Disable USB4 PCIE Tunneling	<p>Disables the USB4 PCIE Tunneling option.</p> <p>By default, the Disable USB4 PCIE Tunneling option is disabled.</p> <p>i NOTE: To view this option, enable Advanced Setup mode as described in View Advanced Setup options.</p>
Video/Power only on Type-C Ports	<p>Enables or disables the Type-C port functionality to video or only power.</p> <p>By default, the Video/Power only on Type-C Ports option is disabled.</p> <p>i NOTE: To view this option, enable Advanced Setup mode as described in View Advanced Setup options.</p>
Miscellaneous Devices	
Enable Fingerprint Reader Device	<p>Enables or disables the Fingerprint Reader Device option.</p> <p>By default, the Enable Fingerprint Reader Device option is enabled.</p> <p>i NOTE: To view this option, enable Advanced Setup mode as described in View Advanced Setup options.</p>
Microphone Mute LED	<p>Enables the LED status of the microphone.</p>

Table 28. System Setup options—Connection menu

Connection	
Wireless Device Enable	
WLAN	Enables or disables the internal WLAN device. By default, the WLAN option is enabled.
Bluetooth	Enables or disables the internal Bluetooth device. By default, the Bluetooth option is enabled.
Enable UEFI Network Stack	Enables or disables the UEFI Network Stack and controls the onboard LAN Controller. By default, the Enable UEFI Network Stack option is enabled. i NOTE: To view this option, enable Advanced Setup mode as described in View Advanced Setup options .
HTTP(s) Boot Feature	
HTTP(s) Boot	When enabled, supports HTTP(s) boot on the client BIOS, which offers wired or wireless and HTTP/HTTPS connection options. i NOTE: To view this option, enable Advanced Setup mode as described in View Advanced Setup options .
HTTP(s) Boot Modes	In Auto Mode, the boot URL is obtained from the DHCP response; the boot URL specifies the HTTP Boot Server and location of the Network Boot Program (NBP) file. In Manual mode, the user enters the URL in the text box, which must start with <code>http://</code> or <code>https://</code> and end with the NBP file name. By default, Auto Mode is selected. i NOTE: To view this option, enable Advanced Setup mode as described in View Advanced Setup options .
CA Certificate	Upload or delete the CA certificate. i NOTE: To view this option, enable Advanced Setup mode as described in View Advanced Setup options .

Table 29. System Setup options—Storage menu

Storage	
Storage Interface	Displays the information of various onboard drives.
Port Enablement	Enables or disables the M.2 PCIe SSD option. By default, the M.2 PCIe SSD option is enabled.
Drive Information	Displays the information of onboard drives.

Table 30. System Setup options—Display menu

Display	
Display Brightness	
Brightness on battery power	Enables to set the screen brightness when the computer is running on battery power. By default, the screen brightness is set to 50 when the computer is running on battery power. i NOTE: To view this option, enable Advanced Setup mode as described in View Advanced Setup options .
Brightness on AC power	Enables to set the screen brightness when the computer is running on AC power.

Table 30. System Setup options—Display menu (continued)



Display	
	<p>By default, the screen brightness is set to 100 when the computer is running on AC power.</p> <p> NOTE: To view this option, enable Advanced Setup mode as described in View Advanced Setup options.</p>
Touchscreen	<p>Enables or disables the touch screen option.</p> <p>By default, the Touchscreen option is enabled.</p> <p> NOTE: To view this option, enable Advanced Setup mode as described in View Advanced Setup options.</p>

Table 31. System Setup options—Power menu

Power	
Thermal Management	<p>Enables or disables cooling of the fan and manages the processor heat to adjust the system performance, noise, and temperature.</p> <p>By default, the Optimized option is selected. Standard settings for balanced performance, noise, and temperature.</p>
Lid Switch	
Enable Lid Switch	<p>Enables or disables the Lid Switch.</p> <p>By default, the Enable Lid Switch option is enabled.</p>
Power On Lid Open	<p>When enabled, allows the computer to turn on when the display is opened.</p> <p>By default, the Power On Lid Open option is disabled.</p>

Table 32. System Setup options—Security menu



Security	
TPM 2.0 Security	<p>Trusted Platform Module (TPM) is a security device that stores computer-generated keys for encryption and features such as BitLocker, Virtual Secure Mode, remote Attestation.</p> <p>By default, the TPM 2.0 Security option is enabled.</p> <p>For additional security, Dell Technologies recommends keeping the Trusted Platform Module (TPM) enabled to allow these security technologies to fully function.</p>
TPM 2.0 Security On	<p>Enables or disables the TPM.</p> <p>By default, the TPM 2.0 Security On option is enabled.</p> <p>For additional security, Dell Technologies recommends keeping TPM enabled to allow these security technologies to fully function.</p> <p> NOTE: To view this option, enable Advanced Setup mode as described in View Advanced Setup options.</p>
Attestation Enable	<p>The Attestation Enable option controls the endorsement hierarchy of TPM. Disabling the Attestation Enable option prevents TPM from being used to digitally sign certificates.</p> <p>By default, the Attestation Enable option is enabled.</p> <p>For additional security, Dell Technologies recommends keeping the Attestation Enable option enabled.</p> <p> NOTE: When disabled, this feature may cause compatibility issues or loss of functionality in some operating systems.</p>

Table 32. System Setup options—Security menu (continued)





Security	
	<p> NOTE: To view this option, enable Advanced Setup mode as described in View Advanced Setup options.</p>
Key Storage Enable	<p>The Key Storage Enable option controls the storage hierarchy of TPM, which is used to store digital keys. Disabling the Key Storage Enable option restricts the ability of TPM to store owner's data.</p> <p>By default, the Key Storage Enable option is enabled.</p> <p>For additional security, Dell Technologies recommends keeping the Key Storage Enable option enabled.</p> <p> NOTE: When disabled, this feature may cause compatibility issues or loss of functionality in some operating systems.</p>
Clear	<p>When enabled, the Clear option clears information that is stored in the TPM after exiting the system's BIOS. This option returns to the disabled state when the computer restarts.</p> <p>By default, the Clear option is disabled.</p> <p>Dell Technologies recommends enabling the Clear option only when TPM data is required to be cleared.</p> <p> NOTE: To view this option, enable Advanced Setup mode as described in View Advanced Setup options.</p>
Physical Presence Interface (PPI) Bypass for Clear Commands	<p>The PPI Bypass for Clear Commands option allows the operating system to manage certain aspects of PTT. When enabled, you are not prompted to confirm changes to the PTT configuration.</p> <p>By default, the PPI Bypass for Clear Commands option is disabled.</p> <p>For additional security, Dell Technologies recommends keeping the PPI Bypass for Clear Commands option disabled.</p>
Chassis Intrusion	
Chassis Intrusion	<p>Enables or disables the detection of chassis intrusion events. This feature notifies the user when the base cover has been removed from the computer.</p> <p>When set to Enabled, a notification is displayed on the next boot and the event is logged in the BIOS Events log.</p> <p>When set to Disabled, no notification is displayed and no event is logged in the BIOS Events log.</p> <p>When set to On-Silent, the event is logged in the BIOS Events log, but no notification is displayed.</p> <p>By default, the Chassis Intrusion Detection option is disabled.</p> <p>For additional security, Dell Technologies recommends keeping the Chassis Intrusion option enabled.</p> <p> NOTE: To view this option, enable Advanced Setup mode as described in View Advanced Setup options.</p>
Data Wipe on Next Boot	
Start Data Wipe	<p>Data Wipe is a secure wipe operation that deletes information from a storage device.</p> <p> CAUTION: The Secure Data Wipe operation erases information in a way that it cannot be reconstructed.</p> <p>Commands such as delete and format in the operating system may remove files from showing up in the file system, however they can be reconstructed through</p>

Table 32. System Setup options—Security menu (continued)



Security	
	<p>forensic means as they are still represented on the physical media. Data Wipe prevents this reconstruction and is not recoverable.</p> <p>When enabled, the BIOS will queue up a data wipe cycle for storage devices that are connected to the motherboard on the next reboot.</p> <p>By default, the Start Data Wipe option is disabled.</p> <p> NOTE: To view this option, enable Advanced Setup mode as described in View Advanced Setup options.</p>
UEFI Boot Path Security	<p>Enables or disables the computer to prompt the user to enter the Administrator password (if set) when booting to a UEFI boot path device from the F12 boot menu.</p> <p>By default, the Always Except Internal HDD option is enabled.</p> <p> NOTE: To view this option, enable Advanced Setup mode as described in View Advanced Setup options.</p>
Pluton Security Processor	<p>Enables or disables the utilization of the Pluton Security Processor by the operating system to provide security services such as Key Storage Provider functionality.</p> <p>By default, the Pluton Security Processor option is enabled.</p> <p> NOTE: For additional security, Dell Technologies recommends keeping the Pluton Security Processor option enabled.</p>

Table 33. System Setup options—Passwords menu

Passwords	
Admin Password	<p>The Administrator Password prevents unauthorized access to the BIOS Setup options. Once the administrator password is set, the BIOS Setup options can only be modified after providing the correct password.</p> <p>The following rules and dependencies apply to the Administrator Password -</p> <ul style="list-style-type: none"> • The administrator password cannot be set if system and/or internal hard drive passwords are previously set. • The administrator password can be used in place of the system and/or internal hard drive passwords. • When set, the administrator password must be provided during a firmware update. • Clearing the administrator password also clears the system password (if set). <p>Dell Technologies recommends using an administrator password to prevent unauthorized changes to BIOS Setup options.</p>
System Password	<p>The System Password prevents the computer from booting to an operating system without entering the correct password.</p> <p>The following rules and dependencies apply when the System Password is used -</p> <ul style="list-style-type: none"> • The computer shuts down when idle for approximately 10 minutes at the system password prompt. • The computer shuts down after three incorrect attempts to enter the system password. • The computer shuts down when the Esc key is pressed at the System Password prompt. • The system password is not prompted when the computer resumes from standby mode. <p>Dell Technologies recommends using the system password in situations where it is likely that a computer may be lost or stolen.</p>

Table 33. System Setup options—Passwords menu (continued)

Passwords	
<p>Hard Drive Password</p> <p>NOTE: On some computers, the M.2 PCIe SSD-0 Password option is shown.</p>	<p>The hard drive password can be set to prevent unauthorized access of the data stored on the solid-state drive. The computer prompts for the hard drive password during boot in order to unlock the drive. A password-secured hard drive stays locked even when removed from the computer or placed into another computer. It prevents an attacker from accessing data on the drive without authorization.</p> <p>The following rules and dependencies apply when the Hard Drive Password or M.2 PCIe SSD-0 Password option is used.</p> <ul style="list-style-type: none"> • The hard drive password option cannot be accessed when the hard drive is disabled in the BIOS Setup. • The computer shuts down when idle for approximately 10 minutes at the hard drive password prompt. • The computer shuts down after three incorrect attempts to enter the hard drive password and treats the hard drive as not available. • The hard drive does not accept password unlock attempts after five incorrect attempts to enter the hard drive password from the BIOS Setup. The hard drive password must be reset for the new password unlock attempts. • The computer treats the hard drive as not available when the Esc key is pressed at the hard drive password prompt. • The hard drive password is not prompted when the computer resumes from standby mode. When the hard drive is unlocked by the user before the computer goes into standby mode, it remains unlocked after the computer resumes from standby mode. • If the system and hard drive passwords are set to the same value, the hard drive unlocks after the correct system password is entered. <p>Dell Technologies recommends using a hard drive password to protect unauthorized data access.</p>
<p>Password Configuration</p>	<p>The Password configuration page includes several options for changing the requirements of BIOS passwords. You can modify the minimum and maximum length of the passwords as well as require passwords to contain certain character classes (upper case, lower case, digit, special character).</p> <p>When the Lower Case Letter option is enabled, the password requires at least one lower case letter.</p> <p>When the Upper Case Letter option is enabled, the password requires at least one upper case letter.</p> <p>When the Digit option is enabled, the password requires at least one numeric digit.</p> <p>When the Special Character option is enabled, the password requires at least one special character from the set: !"#\$\$%&'()*+,-./:;<=>@[\\]^_`{ }~.</p> <p>When setting Minimum Characters for password length, Dell Technologies recommends setting the minimum password length to at least eight characters.</p> <p>NOTE: To view this option, enable Advanced Setup mode as described in View Advanced Setup options.</p>
<p>Password Changes</p>	
<p>Allow Non-Admin Password Changes</p>	<p>The Allow Non-Admin Password Changes option in BIOS Setup allows an end user to set or change the system or hard drive passwords without entering the administrator password. This gives an administrator control over the BIOS settings but enables an end user to provide their own password.</p> <p>By default, the Allow Non-Admin Password Changes option is enabled.</p> <p>For additional security, Dell Technologies recommends keeping the Allow Non-Admin Password Changes option disabled.</p>

Table 33. System Setup options—Passwords menu (continued)

Passwords	
	<p>i NOTE: To view this option, enable Advanced Setup mode as described in View Advanced Setup options.</p>
Non-Admin Setup Changes	<p>The Non-Admin Setup Changes option allows an end user to configure the wireless devices without requiring the administrator password.</p> <p>By default, the Non-Admin Setup Changes option is disabled.</p> <p>For additional security, Dell Technologies recommends keeping the Non-Admin Setup Changes option disabled.</p> <p>i NOTE: To view this option, enable Advanced Setup mode as described in View Advanced Setup options.</p>
Admin Setup Lockout	<p>The Admin Setup Lockout option prevents an end user from even viewing the BIOS Setup configuration without first entering the administrator password (if set).</p> <p>By default, the Enable Admin Setup Lockout option is disabled.</p> <p>For additional security, Dell Technologies recommends keeping the Admin Setup Lockout option disabled.</p> <p>i NOTE: To view this option, enable Advanced Setup mode as described in View Advanced Setup options.</p>
Master Password Lockout	<p>The Master Password Lockout option allows you to disable the Recovery Password feature. If the system, administrator, or hard drive password is forgotten, the computer becomes unusable.</p> <p>i NOTE: When the owner password is set, the Master Password Lockout option is not available.</p> <p>i NOTE: When an internal hard drive password is set, it must first be cleared before Master Password Lockout can be changed.</p> <p>By default, the Enable Master Password Lockout option is disabled.</p> <p>Dell Technologies does not recommend enabling the Master Password Lockout unless you have implemented your own password recovery system.</p> <p>i NOTE: To view this option, enable Advanced Setup mode as described in View Advanced Setup options.</p>
Allow Non-Admin PSID Revert	<p>The Allow Non-Admin PSID Revert option allows a user to clear the hard drive password without entering the BIOS Admin Password. When an Admin Password is set, the ability to enter the PSID is protected by requiring authentication with the Admin Password. If this option is enabled, any user can clear the drive without entering the Admin Password.</p> <p>By default, the Enable Allow Non-Admin PSID Revert option is disabled.</p> <p>i NOTE: To view this option, enable Advanced Setup mode as described in View Advanced Setup options.</p>

Table 34. System Setup options—Update, Recovery menu

Update, Recovery	
BIOS Downgrade	
Allow BIOS Downgrade	<p>Allows downgrading of the system firmware to previous revisions.</p> <p>By default, the Allow BIOS Downgrade option is enabled.</p>

Table 35. System Setup options—System Management menu

System Management	
Service Tag	Displays the Service Tag of the computer.
Asset Tag	Creates a computer Asset Tag that an IT administrator can use to uniquely identify a particular computer. i NOTE: Once set in the BIOS, the Asset Tag cannot be changed.
Wake on AC	Enables or disables the computer to turn on and go to boot when AC power is supplied to the computer. By default, the Wake on AC option is disabled. i NOTE: To view this option, enable Advanced Setup mode as described in View Advanced Setup options .
First Power On Date	Create an ownership date for the computer. i NOTE: To view this option, enable Advanced Setup mode as described in View Advanced Setup options .

Table 36. System Setup options—Keyboard menu

Keyboard	
Fn Lock Options	Enables or disables the Fn Lock option. By default, the Fn Lock option is enabled.
Keyboard Illumination	Configures the operating mode of the keyboard illumination feature. By default, the Bright option is selected. Enables the keyboard illumination feature at 100% brightness level.
Keyboard Backlight Timeout on AC	Sets the timeout value for the keyboard backlight when an AC adapter is connected to the computer. By default, the 10 seconds option is selected. i NOTE: To view this option, enable Advanced Setup mode as described in View Advanced Setup options .
Keyboard Backlight Timeout on Battery	Sets the timeout value for the keyboard backlight when the computer is running only on the battery power. The keyboard backlight timeout value is only effective when the backlight is enabled. By default, the 10 seconds option is selected. i NOTE: To view this option, enable Advanced Setup mode as described in View Advanced Setup options .

Table 37. System Setup options—Pre-boot Behavior menu

Pre-boot Behavior	
Extend BIOS POST Time	Sets the BIOS POST (Power-On Self-Test) load time. By default, the 0 seconds option is selected. i NOTE: To view this option, enable Advanced Setup mode as described in View Advanced Setup options .
MAC Address Pass-Through	Replaces the external NIC MAC address (in a supported dock or dongle) with the selected MAC address from the computer. By default, the System Unique MAC Address option is selected.
Sign of Life	
Early Keyboard Backlight	Enables or disables the Keyboard Backlight Sign of Life.

Table 37. System Setup options—Pre-boot Behavior menu (continued)



Pre-boot Behavior	
	By default, the Early Keyboard Backlight option is enabled.
	 NOTE: To view this option, enable Advanced Setup mode as described in View Advanced Setup options .



Table 38. System Setup options—System Logs menu

System Logs	
BIOS Event Log	
Clear BIOS Event Log	Select the option to keep or clear BIOS events logs. By default, the Keep Log option is selected.
	 NOTE: To view this option, enable Advanced Setup mode as described in View Advanced Setup options .

Updating the BIOS

Updating the BIOS in Windows

About this task

-  **CAUTION:** If BitLocker is not suspended before updating the BIOS, the BitLocker key is not recognized the next time you reboot the computer. You will then be prompted to enter the recovery key to proceed, and the computer displays a prompt for the recovery key on each reboot. Failure to provide the recovery key can result in data loss or an operating system reinstall. For more information, see the Knowledge Base Resource [Updating the BIOS on Dell systems with BitLocker enabled](#).
-  **CAUTION:** Do not turn off the computer during the BIOS flash update process. The computer may not boot if you turn off your computer.

Steps

- Go to [Dell Support Site](#).
- Go to **Identify your product or ask support**. In the box, enter the product identifier, model, service request or describe what you are looking for, and then click **Search**.
 -  **NOTE:** If you do not have the Service Tag, click **Detect This PC**. The site automatically detects your device, and you can then click **Explore Product Support** to go to the support page for your device. You can also use the product ID or manually browse for your computer model.
- Click **Drivers & Downloads**.
- Select the operating system installed on your computer.
- In the **Category** drop-down list, select **BIOS**.
- Select the latest version of BIOS, and click **Download** to download the BIOS file for your computer.
- After the download is complete, navigate to the folder where the BIOS update file has been saved.
- Double-click the BIOS update file and follow the on-screen instructions.
For more information, search in the Knowledge Base Resource at [Dell Support Site](#).

Updating the BIOS using the USB drive in Windows

About this task

CAUTION: If BitLocker is not suspended before updating the BIOS, the BitLocker key is not recognized the next time you reboot the computer. You will then be prompted to enter the recovery key to proceed, and the computer displays a prompt for the recovery key on each reboot. Failure to provide the recovery key can result in data loss or an operating system reinstall. For more information, see the Knowledge Base Resource [Updating the BIOS on Dell systems with BitLocker enabled](#).

CAUTION: Do not turn off the computer during the BIOS flash update process. The computer may not boot if you turn off your computer.

Steps

1. Go to [Dell Support Site](#).
2. Go to **Identify your product or ask support**. In the box, enter the product identifier, model, service request or describe what you are looking for, and then click **Search**.
NOTE: If you do not have the Service Tag, click **Detect This PC**. The site automatically detects your device, and you can then click **Explore Product Support** to go to the support page for your device. You can also use the product ID or manually browse for your computer model.
3. Click **Drivers & Downloads**.
4. Select the operating system installed on your computer.
5. In the **Category** drop-down list, select **BIOS**.
6. Select the latest version of BIOS, and click **Download** to download the BIOS file for your computer.
7. Create a bootable USB drive. For more information, search the Knowledge Base Resource at [Dell Support Site](#).
8. Copy the BIOS Setup program file to the bootable USB drive.
9. Connect the bootable USB drive to the computer that needs the BIOS update.
10. Restart the computer and press **F12**.
11. Select the USB drive from the **One Time Boot Menu**.
12. Type the BIOS Setup program filename and press **Enter**.
The **BIOS Update Utility** appears.
13. Follow the on-screen instructions to complete the BIOS update.

Updating the BIOS from the One-Time boot menu

To update the BIOS from the One-Time boot menu, see Knowledge base article [000128928](#) at [Dell Support Site](#).

System and setup password

CAUTION: The password features provide a basic level of security for the data on your computer.

CAUTION: Ensure that your computer is locked when it is not in use. Anyone can access the data that is stored on your computer, when left unattended.

Table 39. System and setup password

Password type	Description
System password	Password that you must enter to boot to your operating system.
Setup password	Password that you must enter to access and change the BIOS settings of your computer.

You can create a system password and a setup password to secure your computer.

 **NOTE:** The System and setup password feature is disabled by default.

Assigning a System Setup password

Prerequisites

You can assign a new System or Admin Password only when the status is set to **Not Set**. To enter BIOS System Setup, press F2 immediately after a power-on or reboot.

Steps

1. To enter the **System Setup**, press **F2** immediately after a power-on or reboot.
2. In the **System BIOS** or **System Setup** screen, select **Security** and press Enter.
The **Security** screen is displayed.
3. Select **System/Admin Password** and create a password in the **Enter the new password** field.
Use the following guidelines to create the system password:
 - Password can be up to 32 characters.
 - Password must contain at least one special character: "(! " # \$ % & ' * + , - . / : ; < = > ? @ [\] ^ _ ` { | })"
 - The password can contain numbers from 0 to 9.
 - The password can contain alphabets A to Z and a to z.
4. Type the system password that you entered earlier in the **Confirm new password** field and click **OK**.
5. Press Y to save the changes.
The computer restarts.

Deleting or changing an existing system password or setup password

Prerequisites

Ensure that the **Password Status** is Unlocked in the System Setup before attempting to delete or change the existing system password and/or setup password. You cannot delete or change an existing system password or setup password if the **Password Status** is Locked. To enter the System Setup, press F2 immediately after a power-on or reboot.

Steps

1. To enter the **System Setup**, press **F2** immediately after a power-on or reboot.
2. In the **System BIOS** or **System Setup** screen, select **System Security** and press Enter.
The **System Security** screen is displayed.
3. In the **System Security** screen, verify that the **Password Status** is Unlocked.
4. Select **System Password**. Update or delete the existing system password, and press Enter or Tab.
5. Select **Setup Password**. Update or delete the existing setup password, and press Enter or Tab.
 **NOTE:** If you change the system password and/or setup password, reenter the new password when prompted. If you delete the system password and/or setup password, confirm the deletion when prompted.
6. Press Esc. A message prompts you to save the changes.
7. Press Y to save the changes and exit from **System Setup**.
The computer restarts.

Clearing system and setup passwords

About this task

To clear the system or setup passwords, contact Dell technical support as described at [Contact Support](#).

NOTE: For information about how to reset Windows or application passwords, see the documentation accompanying Windows or your application.

Clearing chassis intrusion alert

The computer features a chassis intrusion switch that detects when the base cover had been removed from the computer. Alerts to notify you of any intrusions can be enabled through the **Chassis Intrusion** field in the **Security** submenu of the BIOS setup menu.

When enabled, the **Block Boot Until Cleared** field allows you to choose whether to prevent normal boot-up of the computer until the intrusion alert is cleared.

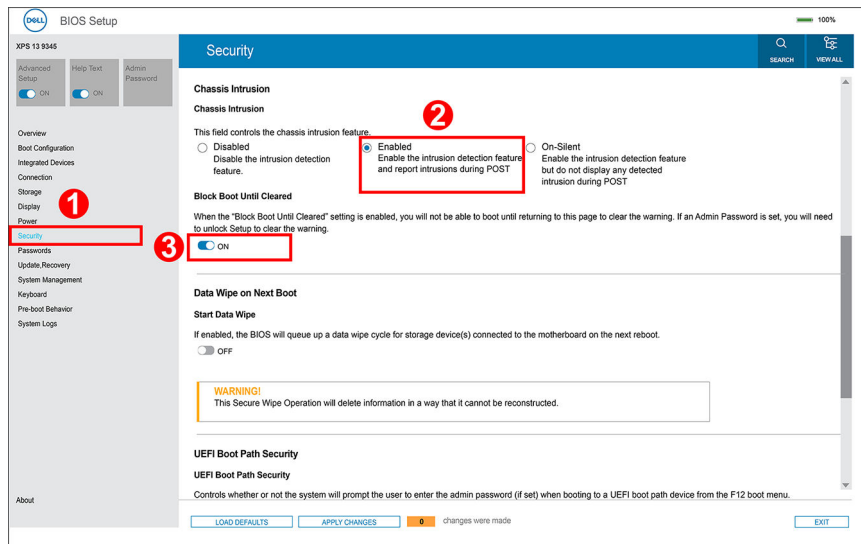

Figure 63. Block boot until cleared

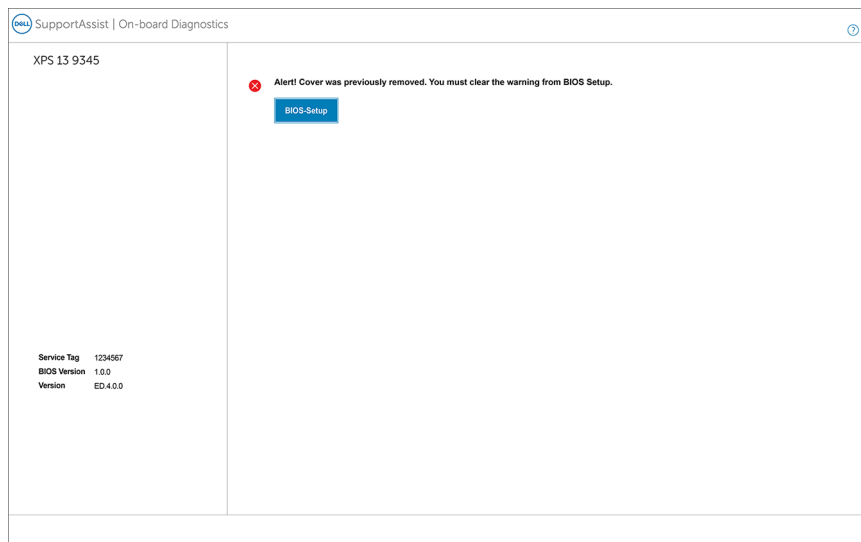

Figure 64. BIOS setup

If **Block Boot Until Cleared** is set to **OFF**, select **Continue** to boot up or **BIOS-Setup** to clear the alert.

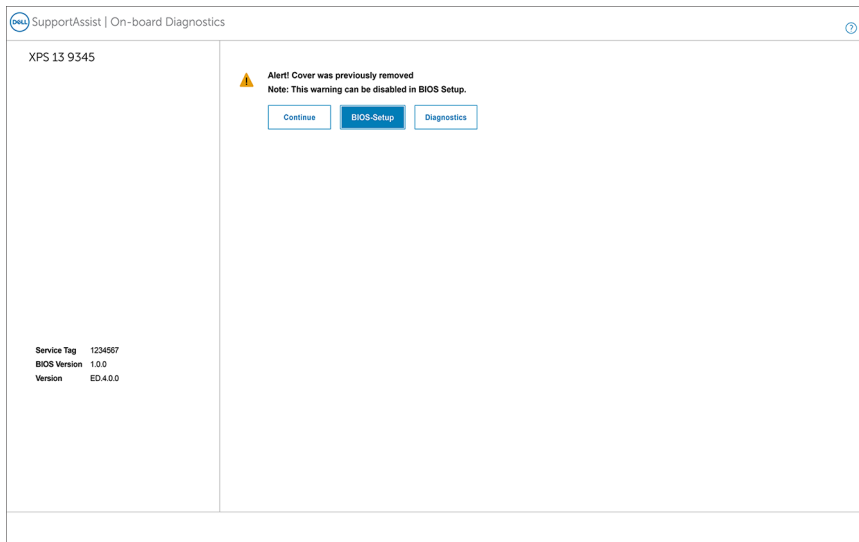

Figure 65. BIOS setup

NOTE: If **Continue** is selected, the user continues to see the alert each time the computer is turned on until the alert is cleared.

To clear the alert, select **ON** in the **Clear Intrusion Warning** field in the **Security** submenu of the BIOS setup menu.

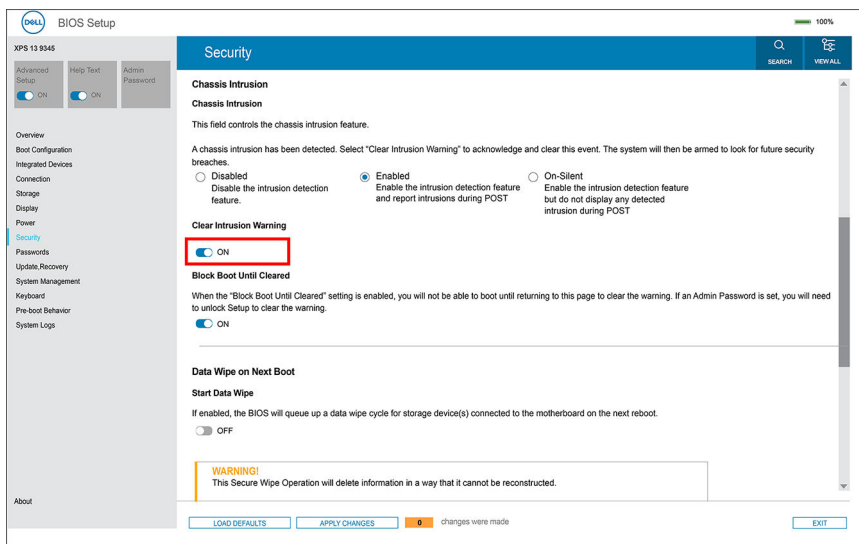

Figure 66. Clear intrusion warning

Troubleshooting

Handling swollen rechargeable Li-ion batteries

Like most laptops, Dell laptops use Lithium-ion batteries. One type of Lithium-ion battery is the rechargeable Li-ion battery. Rechargeable Li-ion batteries have increased in popularity in recent years and have become a standard in the electronics industry due to customer preferences for a slim form factor (especially with newer ultra-thin laptops) and long battery life. Inherent to rechargeable Li-ion battery technology is the potential for swelling of the battery cells.

A swollen battery may impact the performance of the laptop. To prevent possible further damage to the device enclosure or internal components leading to malfunction, discontinue the use of the laptop and discharge it by disconnecting the AC adapter and letting the battery drain.

Swollen batteries should not be used and must be replaced and disposed of properly. We recommend contacting Dell Support for options to replace a swollen battery under the terms of the applicable warranty or service contract, including options for replacement by a Dell authorized service technician.

The guidelines for handling and replacing rechargeable Li-ion batteries are as follows:

- Exercise caution when handling rechargeable Li-ion batteries.
- Discharge the battery before removing it from the laptop. To discharge the battery, unplug the AC adapter from the computer and operate the computer only on battery power. The battery is fully discharged when the computer no longer turns on when the power button is pressed.
- Do not crush, drop, mutilate, or penetrate the battery with foreign objects.
- Do not expose the battery to high temperatures, or disassemble battery packs and cells.
- Do not apply pressure to the surface of the battery.
- Do not bend the battery.
- Do not use tools of any type to pry on or against the battery.
- If a battery gets stuck in a device as a result of swelling, do not try to free it as puncturing, bending, or crushing a battery can be dangerous.
- Do not attempt to reassemble a damaged or swollen battery into a laptop.
- Swollen batteries that are covered under warranty should be returned to Dell in an approved shipping container (provided by Dell)—this is to comply with transportation regulations. Swollen batteries that are not covered under warranty should be disposed of at an approved recycling center. Contact Dell Support at [Dell Support Site](#) for assistance and further instructions.
- Using a non-Dell or incompatible battery may increase the risk of fire or explosion. Replace the battery only with a compatible battery purchased from Dell that is designed to work with your Dell computer. Do not use a battery from other computers with your computer. Always purchase genuine batteries from [Dell Site](#) or otherwise directly from Dell.

Rechargeable Li-ion batteries can swell for various reasons such as age, number of charge cycles, or exposure to high heat. For more information about how to improve the performance and lifespan of the laptop battery and to minimize the possibility of occurrence of the issue, search Dell laptop battery in the Knowledge Base Resource at [Dell Support Site](#).

Locating the Service Tag or Express Service Code of your Dell computer

Your Dell computer is uniquely identified with a Service Tag or Express Service Code. To view relevant support resources for your Dell computer, we recommend entering the Service Tag or Express Service Code at [Dell Support Site](#).

For more information about how to find the Service Tag for your computer, see [Instructions on how to find your Service Tag or Serial Number](#).

Dell SupportAssist Pre-boot System Performance Check diagnostics

About this task

SupportAssist diagnostics (also known as system diagnostics) performs a complete check of your hardware. The Dell SupportAssist Pre-boot System Performance Check diagnostics is embedded within the BIOS and launched by the BIOS internally. The embedded system diagnostics provides options for particular devices or device groups allowing you to:

- Run tests automatically or in an interactive mode.
- Repeat the tests.
- Display or save test results.
- Run thorough tests to add more options and obtain details about any failed devices.
- View status messages that inform you when the tests are completed successfully.
- View error messages that inform you of problems encountered during testing.

 **NOTE:** Some tests for specific devices require user interaction. Always ensure that you are present at the computer when the diagnostic tests are performed.

For more information, see the knowledge base article [000181163](#).

Running the SupportAssist Pre-Boot System Performance Check

Steps

1. Turn on your computer.
2. As the computer boots, press the F12 key.
3. On the boot menu screen, select **Diagnostics**.
The diagnostic quick test begins.

 **NOTE:** For more information about running the SupportAssist Pre-Boot System Performance Check on a specific device, see [Dell Support Site](#).

4. If there are any issues, error codes are displayed.
Note the error code and validation number and contact Dell.

Built-in self-test (BIST)

LCD Built-in Self-Test (LCD-BIST)

Dell laptops have a built-in diagnostic tool that helps you determine if the screen abnormality you are experiencing is an inherent problem with the LCD (screen) of the Dell laptop or with the video card (GPU) and computer settings.

When you notice screen abnormalities like flickering, distortion, clarity issues, fuzzy or blurry image, horizontal or vertical lines, color fade, it is always a good practice to isolate the LCD (screen) by running the LCD-BIST.

How to invoke the LCD-BIST

1. Turn off your computer.
2. Disconnect any peripherals that are connected to the computer. Connect only the AC adapter (charger) to the computer.
3. Ensure that the LCD (screen) is clean (no dust particles on the surface of the screen).
4. Press and hold the **D** key and press the power button to enter LCD-BIST mode. Continue to hold the **D** key until the computer boots up.
5. The screen displays solid colors and changes colors on the entire screen to white, black, red, green, and blue twice.
6. Then it displays the colors white, black, and red.
7. Carefully inspect the screen for abnormalities (any lines, fuzzy color, or distortion on the screen).
8. At the end of the last solid color (red), the computer shuts down.

NOTE: Dell SupportAssist Preboot diagnostics upon launch initiates an LCD-BIST first, expecting a user intervention to confirm functionality of the LCD.

LCD Power rail test (L-BIST)

L-BIST is an enhancement to the single LED error code diagnostics and is automatically initiated during POST. L-BIST checks the LCD power rail. If there is no power being supplied to the LCD (that is if the L-BIST circuit fails), the service LED flashes an error code [2,8].

NOTE: If L-BIST fails, LCD-BIST cannot function as no power is supplied to the LCD.

How to invoke the L-BIST Test

1. Press the power button to start the computer.
2. If the service LED flashes an error code [2,8], there is a failure on the LCD power rail of the system board and no power is supplied to the LCD display. In this scenario, replace the system board.

System-diagnostic lights

This section lists the system-diagnostic lights of your XPS 13 9345. The system-diagnostic light codes are visible through the service LED at the top of the computer.

Table 40. System-diagnostic lights

Blinking pattern		Problem description
Amber	White	
1	3	Short in the hinge cable tripped OCP1
1	4	Short in the hinge cable tripped OCP2
2	2	System board failure (included BIOS corruption or ROM error)
2	8	LCD failure (EC detection of power rail failure)

Backup media and recovery options

It is recommended to create a recovery drive to troubleshoot and fix problems that may occur with Windows. Dell provides multiple options for recovering the Windows operating system on your Dell computer. For more information, see [Dell Windows Backup Media and Recovery Options](#).

Network power cycle

About this task

If your computer is unable to access the Internet due to network connectivity issues, reset your network devices by performing the following steps:

Steps

1. Turn off the computer.
2. Turn off the modem.
NOTE: Some Internet service providers (ISPs) provide a modem and router combo device.
3. Turn off the wireless router.

4. Wait for 30 seconds.
5. Turn on the wireless router.
6. Turn on the modem.
7. Turn on the computer.

Drain flea power (perform hard reset)

About this task

Flea power is the residual static electricity that remains in the computer even after it has been powered off and the battery is removed.

For your safety, and to protect the sensitive electronic components in your computer, you must drain residual flea power before removing or replacing any components in your computer.

Draining flea power, also known as performing a "hard reset," is also a common troubleshooting step if your computer does not turn on or boot into the operating system.

Perform the following steps to drain the flea power:

Steps

1. Turn off the computer.
2. Disconnect the power adapter from the computer.
3. Remove the base cover.
4. Remove the battery.



CAUTION: The battery is a Field Replaceable Unit (FRU) and the removal and installation procedures are intended for authorized service technicians only.

5. Press and hold the power button for 20 seconds to drain the flea power.
6. Install the battery.
7. Install the base cover.
8. Connect the power adapter to the computer.
9. Turn on the computer.



NOTE: For more information about performing a hard reset, go to [Dell Support Site](#). On the menu bar at the top of the Support page, select Support > Support Library. In the Search field on the Support Library page, type the keyword, topic, or model number, and then click or tap the search icon to view the related articles.

Getting help and contacting Dell

Self-help resources

You can get information and help on Dell products and services using these self-help resources:

Table 41. Self-help resources

Self-help resources	Resource location
Information about Dell products and services	Dell Site
Contact Support	In Windows search, type <code>Contact Support</code> , and press Enter.
Online help for operating system	Windows Support Site
Access top solutions, diagnostics, drivers and downloads, and learn more about your computer through videos, manuals, and documents.	Your Dell computer is uniquely identified by a Service Tag or Express Service Code. To view relevant support resources for your Dell computer, enter the Service Tag or Express Service Code at Dell Support Site . For more information about how to find the Service Tag for your computer, see Instructions on how to find your Service Tag or Serial Number .
Dell knowledge base articles	<ol style="list-style-type: none"> 1. Go to Dell Support Site. 2. On the menu bar at the top of the Support page, select Support > Support Library. 3. In the Search field on the Support Library page, type the keyword, topic, or model number, and then click or tap the search icon to view the related articles.

Contacting Dell

To contact Dell for sales, technical support, or customer service issues, see [Contact Support at Dell Support Site](#).

 **NOTE:** Availability of the services may vary depending on the country or region, and product.

 **NOTE:** If you do not have an active Internet connection, you can find contact information about your purchase invoice, packing slip, bill, or Dell product catalog.