

# Air conditioner

# User manual

---

**AR60H\*\*D1\*\*\***

---

- Thank you for purchasing this Samsung air conditioner.
- Before operating this unit, please read this manual carefully and retain it for future reference.

# Contents

---

<b>Safety Information</b>	<b>4</b>
Safety Information	4
<b>At a Glance</b>	<b>11</b>
Indoor Unit Overview	11
Display	12
<b>Remote Control Overview</b>	<b>13</b>
Replacing the remote control batteries	13
<b>Remote Control Operation</b>	<b>14</b>
Selecting an operation mode	14
To set the temperature • To adjust the fan speed • To adjust the airflow direction	15
<b>Smart Features</b>	<b>16</b>
<b>Power Smart Features</b>	<b>16</b>
WindFree Cooling function	16
Dry Comfort function	17
AI Auto mode • AI Energy mode	18
Auto mode • Cool mode	19
Dry mode • Fan mode	20
<b>Variety Smart Features</b>	<b>21</b>
Fast function	21
5 Step Cooling function	22
Quiet function	23
Electricity consumption check • Beep function	24
Auto clean function	25
Freeze Wash function	27
Display lighting function • Wi-Fi function (SmartThings app)	28
<b>Time Scheduling</b>	<b>29</b>
Timed on/ Timed off function	29
Good Sleep function	30

<b>Cleaning and Maintenance</b>	<b>31</b>
Schedule	31
Cleaning	32
<b>Appendix</b>	<b>35</b>
Troubleshooting	35
SmartThings app	38



***Correct Disposal of This Product  
(Waste Electrical & Electronic Equipment)***

**(Applicable in countries with separate collection systems)**

This marking on the product, accessories or literature indicates that the product and its electronic accessories (e.g. charger, headset, USB cable) should not be disposed of with other household waste at the end of their working life. To prevent possible harm to the environment or human health from uncontrolled waste disposal, please separate these items from other types of waste and recycle them responsibly to promote the sustainable reuse of material resources.

Household users should contact either the retailer where they purchased this product, or their local government office, for details of where and how they can take these items for environmentally safe recycling.

Business users should contact their supplier and check the terms and conditions of the purchase contract. This product and its electronic accessories should not be mixed with other commercial wastes for disposal.

For more information on safe disposal and recycling, visit our website [www.samsung.com/in/support](http://www.samsung.com/in/support) or contact our Helpline numbers - 1800 40 7267864 (1800 40 SAMSUNG)

1800 5 7267864 (1800 5 SAMSUNG).



***Correct disposal of batteries in this product***

This marking on the battery, manual or packaging indicates that the batteries in this product should not be disposed of with other household waste at the end of their working life. Where marked, the chemical symbols Hg, Cd or Pb indicate that the battery contains mercury, cadmium or lead above the reference levels in EC Directive 2006/66.

# Safety Information

---

## **WARNING: Read This Manual**

Read and follow all safety information and instructions before installation, use, or maintenance of this appliance. Incorrect installation, use, or maintenance of this appliance can result in death, serious injury, or property damage. Keep these instructions with this appliance. This manual is subject to change. For the latest version, visit [www.samsung.com](http://www.samsung.com).

Because the instructions in this manual cover various models, the characteristics of your air conditioner may differ slightly from those described. If you have any questions, please contact your service provider or visit [www.samsung.com](http://www.samsung.com).

## **Notices and notes**

---

To make you aware of safety messages and highlighted information, we use the following notices and notes throughout this manual:

### **WARNING**

Hazards or unsafe practices that may result in severe personal injury or death.

### **CAUTION**





Hazards or unsafe practices that may result in minor personal injury or property damage.

### **IMPORTANT**

Information of special interest

### **NOTE**

Supplementary information that may be useful

Symbol	Meaning
	<b>WARNING: Low burning velocity material</b> (This appliance is filled with R-32.)
	Refer to operating manual
	Read operating manual
	Read installation and service manual

## FOR GENERAL

This appliance is not intended for use by persons (including children) with reduced physical, sensory or mental capabilities, or lack of experience and knowledge, unless they have been given supervision or instruction concerning use of the appliance by a person responsible for their safety. Children should be supervised to ensure that they do not play with the appliance.

## FOR INSTALLATION

### **WARNING**

Use a power cord with this product's power specifications or higher and use the power cord for this appliance only. In addition, do not use an extension cord.

- Extending the power cord may result in electric shock or fire.
- Do not use an electric transformer. This may result in electric shock or fire.
- If the voltage/frequency/rated current condition is different, it may cause fire.

The installation of this appliance must be performed by a qualified technician or service company. Do not attempt to install the air conditioner yourself.

- Failing to do so may result in electric shock, fire, explosion, problems with the product, or injury and may also void warranty on the installed product.

Install an Isolation Switch next to the Air Conditioner (but not on the panels of the Air Conditioner) and circuit breaker dedicated to the air conditioner.

- Failing to do so may result in electric shock or fire.

# Safety Information

---

**Fix the outdoor unit firmly so that the electric part of the outdoor unit is not exposed.**

- Failing to do so may result in electric shock, fire, explosion, or problems with the product.

**Do not install this appliance near a heater, or flammable material. Do not install this appliance in a humid, oily or dusty location, in a location exposed to direct sunlight and water (or rain). Do not install this appliance in a location where gas may leak.**

- This may result in electric shock or fire.

**Never install the outdoor unit in a location such as on a high external wall where it could fall.**

- If the outdoor unit falls, it may result in injury, death or property damage.

**This appliance must be properly grounded. Do not ground the appliance to a gas pipe, plastic, water pipe, or telephone line.**

- Failing to do so may result in electric shock, fire, and explosion.
- Make sure to use a socket-outlet with ground.

**The product shall be stored in a room with no ignition sources (e.g. open flames, gas appliance, electric heater, etc.).**

- Note that the refrigerant has no odour.



## CAUTION

**Install your appliance on a level and hard floor that can support its weight.**

- Failing to do so may result in abnormal vibrations, noise, or problems with the product.

**Install the drain hose properly so that water drains correctly.**

- Failing to do so may result in water overflowing and property damage. Avoid adding drain to waste pipes as odours may arise in the future.

**When installing the outdoor unit, make sure to connect the drain hose so that draining is performed correctly.**

- The water generated during heating by the outdoor unit may overflow and result in property damage. In particular, in winter, if a block of ice falls, it may result in injury, death or property damage.

**Do not install the product in a place where thermo-hygrostat is needed (such as server room, machinery room, computer room, etc.)**

- Those places do not provide guaranteed operation condition of the product therefore performance can be poor in these places.

---

## FOR POWER SUPPLY

---

### WARNING

When the circuit breaker is damaged, contact your nearest service centre.

Do not pull or excessively bend the power line. Do not twist or tie the power line. Do not hook the power line over a metal object, place a heavy object on the power line, insert the power line between objects, or push the power line into the space behind the appliance.

- This may result in electric shock or fire.

If the supply cord is damaged, it must be replaced by the manufacturer, its service agent or similarly qualified persons in order to avoid a hazard.

### CAUTION

When not using the air conditioner for a long period of time or during a thunder/lightning storm, cut the power at the circuit breaker.

- Failing to do so may result in electric shock or fire.

---

## FOR USING

---

### WARNING

If the appliance is flooded, please contact your nearest service centre.

- Failing to do so may result in electric shock or fire.

If the appliance generates a strange noise, a burning smell or smoke, cut off the power supply immediately and contact the nearest service centre.

- Failing to do so may result in electric shock or fire.

If the air conditioner malfunctions or requires repair, immediately stop its operation and disconnect the entire power system. Then consult the authorized service personnel.

In the event of a gas leak (such as propane gas, LP gas, etc.), ventilate immediately without touching the power line. Do not touch the appliance or power line.

- Do not use a ventilating fan.
- A spark may result in an explosion or fire.

# Safety Information

---

**To reinstall the air conditioner, please contact your nearest service centre.**

- Failing to do so may result in problems with the product, water leakage, electric shock, or fire.
- Delivery service for the product is not provided. If you reinstall the product in another location, additional construction expenses and an installation fee will be charged.
- Especially, when you wish to install the product in an unusual location such as in an industrial area or near the seaside where it is exposed to salt in the air, please contact your nearest service centre.

**Do not touch the circuit breaker with wet hands.**

- This may result in electric shock.

**Do not turn the air conditioner off with the circuit breaker while it is operating.**

- Turning the air conditioner off and then on again with the circuit breaker may cause a spark and result in electric shock or fire.

**After unpacking the air conditioner, keep all packaging materials well out of the reach of children, as packaging materials can be dangerous to children.**

- If a child places a bag over its head, it may result in suffocation.

**Do not touch the airflow blade with your hands or fingers during heating.**

- This may result in electric shock or burns.

**Do not insert your fingers or foreign substances into the air inlet/outlet of the air conditioner.**

- Take special care that children do not injure themselves by inserting their fingers into the product.

**Do not strike or pull the air conditioner with excessive force.**

- This may result in fire, injury, or problems with the product.

**Do not place an object near the outdoor unit that allows children to climb onto the machine.**

- This may result in children seriously injuring themselves.

**Do not use this air conditioner for long periods of time in badly ventilated locations or near infirm people.**

- Since this may be dangerous due to a lack of oxygen, open a window at least once an hour.

**Do not use means to accelerate the defrost operation or to clean, other than those recommended by Samsung.**

**Do not pierce or burn.**

**Be aware that refrigerants may not contain an odour.**

**If any foreign substance such as water has entered the appliance, cut off the power supply and contact the nearest service centre.**

- Failing to do so may result in electric shock or fire.

**Do not attempt to repair, disassemble, or modify the appliance yourself.**

- Do not use any fuse (such as copper, steel wire, etc.) other than the standard fuse.
- Failing to do so may result in electric shock, fire, problems with the product, or injury.

---

 **CAUTION**

**Do not place objects or devices under the indoor unit.**

- Water dripping from the indoor unit may result in fire or property damage.

**Check that the installation frame of the outdoor unit is not broken at least once a year.**

- Failing to do so may result in injury, death or property damage.

**To prevent personal injury, make sure that you change the directions of the horizontal airflowblades after stopping the movements of the vertical airflowblade. (In case of adjusting the horizontal airflow manually)**

**When the air conditioner does not operate properly for cooling or heating, there is a possibility of refrigerant leakage. If any leakage, stop operation, ventilate the room, and consult your dealer immediately for recharging refrigerant.**

**The refrigerant is not harmful. However, if it comes in contact with fire, it may generate harmful gases and there is risk of fire.**

**During transportation of the indoor unit, the pipe lines shall be covered with brackets for protection. Do not move the product with holding the pipe lines.**

- It may cause gas leakage.

**Do not install the product in a ship or a vehicle (such as a campervan).**

- Salt, vibration or other environmental factor may cause the product malfunction, electric shock or fire.

**Do not stand on top of the appliance or place objects (such as laundry, lighted candles, lighted cigarettes, dishes, chemicals, metal objects, etc.) on the appliance.**

- This may result in electric shock, fire, problems with the product, or injury.

**Do not operate the appliance with wet hands.**

- This may result in electric shock.

**Do not spray volatile material such as insecticide onto the surface of the appliance.**

- As well as being harmful to humans, it may also result in electric shock, fire or problems with the product.

**Do not drink the water from the air conditioner.**

- The water may be harmful to humans.

**Do not hit, shake, drop, or attempt to disassemble the remote control.**

**When replacing the remote control batteries, keep them out of the reach of infants.**

- If an infant eats batteries, contact a doctor immediately.

**When replacing the remote control batteries, be careful not to get the battery fluid on your skin.**

- Battery fluid is harmful to humans.

# Safety Information

---

Do not touch the pipes connected with the product.

- This may result in burns or injury.

Do not cut or burn the refrigerant container or pipings.

Do not point the air direction to the fireplace or heater.

Do not use this air conditioner to preserve precision equipment, food, animals, plants or cosmetics, or for any other unusual purposes.

- This may result in property damage.

Avoid directly exposing humans, animals or plants to the airflow from the air conditioner for long periods of time.

- This may result in harm to humans, animals or plants.

## FOR CLEANING

---



### WARNING

Do not clean the appliance by spraying water directly onto it. Do not use benzene, thinner or alcohol to clean the appliance.

- This may result in discolouration, deformation, damage, electric shock or fire.

Before cleaning, servicing, or performing maintenance, make sure to disconnect the product from its power source and wait until the fan stops.

- Failing to do so may result in electric shock or fire.



### CAUTION

Take care when cleaning the surface of the heat exchanger of the outdoor unit since it has sharp edges.

- This should be done by a qualified technician. Please contact your installer or service centre.

Do not clean the inside of the air conditioner by yourself.

- For cleaning inside the appliance, contact your nearest service centre.
- When cleaning the filter, refer to the descriptions in the 'Cleaning' section.
- Failing to do so may result in damage, electric shock or fire.
- Make sure to prevent any injury from sharp edges of the surface when handling the heat exchanger.

# Indoor Unit Overview

The appearance of the actual product may differ slightly from the image below.

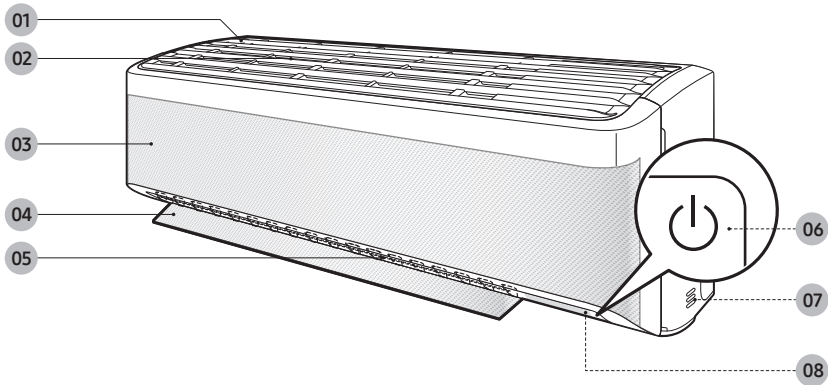

- 01 Air intake
- 02 Air filter
- 03 WindFree panel
- 04 Airflow blade (up and down)
- 05 Airflow blade (left and right)
- 06 Power button/Remote control receiver
- 07 Room temperature sensor
- 08 Display

# Indoor Unit Overview

## Display

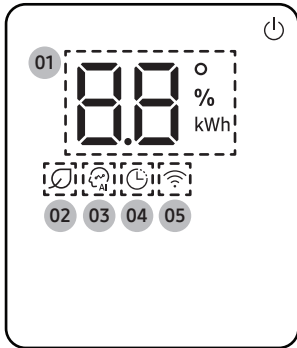

- 01 Temperature indicator (numeric) /  
Filter reset indicator ( F ) /  
Electricity consumption indicator (numeric) /  
Auto clean indicator ( )
- 02 AI Energy indicator
- 03 AI Auto indicator
- 04 Timer indicator /  
Good Sleep indicator
- 05 Wi-Fi indicator

### NOTE

- When the Wi-Fi is turned on, the indicator blinks three times and then turn on.

### NOTE

- If the Wi-Fi indicator blinks for 10 seconds when operation starts, it means that the air conditioner is not connected to Wi-Fi. See "SmartThings app" on page 38 and connect the air conditioner to Wi-Fi.
- When connected to Wi-Fi, the air conditioner can gather and learn your user patterns so that it can run in AI Auto mode.

# Remote Control Overview

Most operating instructions in this manual require using the remote control.

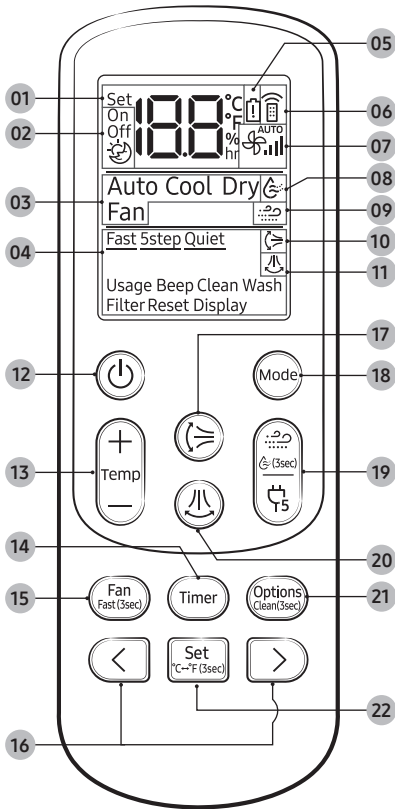

- 01 Set temperature indicator
- 02 Timer option indicator
- 03 Operation mode indicator
- 04 Options indicator
- 05 Low battery indicator
- 06 Transmit indicator
- 07 Fan speed indicator
- 08 Dry Comfort indicator
- 09 WindFree indicator
- 10 Vertical air swing indicator
- 11 Horizontal air swing indicator
- 12 Power button
- 13 Temperature button
- 14 Timer button
- 15 Fan speed/Fast button
- 16 Direction button/Selection button
- 17 Vertical air swing button
- 18 Mode button
- 19 WindFree/Dry Comfort/5 Step Cooling button
- 20 Horizontal air swing button
- 21 Options/Clean button
- 22 SET button/Temperature type button(°C↔°F)

## Replacing the remote control batteries

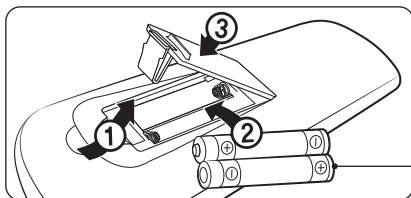

Two 1.5V AAA batteries

# Remote Control Operation

You can use the air conditioner easily by selecting a mode and then by controlling the temperature, fan speed, and air direction.

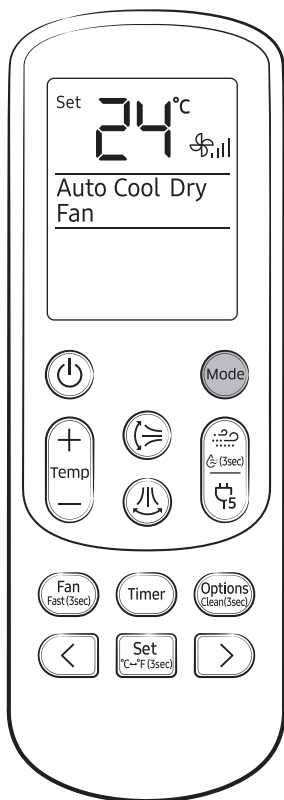

## Selecting an operation mode

To change the current mode between Auto, Cool, Dry, and Fan, press the **Mode** (Mode) button.

You can use AI Auto mode after Wi-Fi is connected.

### **NOTE**

- You can use the Cool, Dry modes in the following operation range.

Mode	Cool	Dry
Indoor temperature	16 °C to 32 °C	18 °C to 32 °C
Outdoor temperature	15 °C to 52 °C	15 °C to 52 °C
Indoor humidity	Relative humidity of 80 % or less <sup>1)</sup>	-

<sup>1)</sup> If the air conditioner operates in Cool mode in a high-humidity environment for an extended period of time, condensation may occur.

You can switch between Celsius and Fahrenheit indications on the remote control.



▶ Press and hold for 3 or more seconds.

### **NOTE**

- The temperature indications on the indoor unit are not switched.
- This function is canceled when the remote control batteries are replaced. In this case, run this function again.

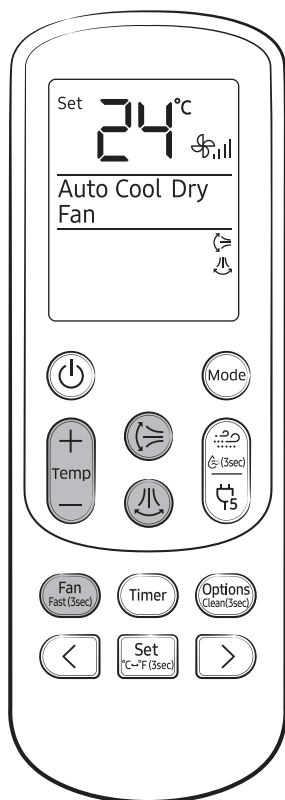











## To set the temperature

To control the temperature in each mode, press the  (Temperature) button:

Mode	Temperature control
AI Auto/Auto/Cool	Adjust by 1 °C from 16 °C to 30 °C.
Dry	Adjust by 1 °C from 18 °C to 30 °C.
Fan	No temperature control.

## To adjust the fan speed

Select from the following fan speeds in each mode:

Mode	Available fan speeds
AI Auto/Auto/Dry	 (Auto)
Cool	 (Auto),  (Low),  (Med),  (High),  (Turbo)
Fan	 (Low),  (Med),  (High),  (Turbo)

## To adjust the airflow direction

Keep the airflow in a constant direction by stopping the movements of the vertical and horizontal airflow blades.

In operation ►  or 

### NOTE

- If you adjust the vertical airflow blade manually, it may not close completely when you turn off the air conditioner.
- Always use the remote control to adjust the airflow blades. Do not move the blades by hand. They may not operate normally.
- You cannot control the vertical airflow direction in Cool mode when the Good Sleep function is on.

# Power Smart Features

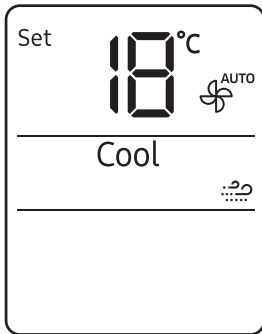



## WindFree Cooling function

Use the WindFree Cooling function to enjoy a mild breeze coming through fine holes in the WindFree panel instead of air coming directly through the airflow blades.

In Cool/Dry/Fan mode ► 

### NOTE

- To cancel this function, press the  (WindFree) button again.
- When the WindFree Cooling function is on, the air conditioner automatically controls the fan speed to keep your room mild and comfortable.
- When the WindFree Cooling function is canceled, the air conditioner returns to the original fan speed and air comes out of the airflow blades.
- In Cool mode, the recommended set temperature during the WindFree Cooling operation is 24 °C to 26 °C.
- You can use the WindFree Cooling function in Cool, Dry, or Fan mode.
- You cannot select the Quiet function during the WindFree Cooling operation.
- Selecting the WindFree Cooling function cancels the Dry Comfort, Fast, 5 Step Cooling, and airflow direction (, ) functions.

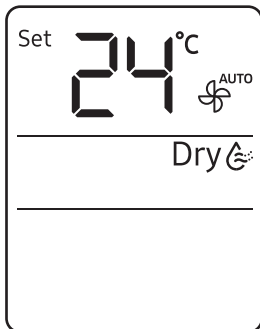

## Dry Comfort function

This dehumidification feature maintains comfortable humidity levels and saves energy by adjusting humidity according to the set temperature.

In operation ►  ► Press and hold for 3 or more seconds.

### NOTE

- The set temperature can be adjusted by 1 °C within the range of 18 °C to 30 °C.
- The fan speed is automatically adjusted.
- The airflow direction is automatically adjusted.  
If the Dry Comfort feature is in use and you select Horizontal or Vertical, the feature turns off.
- If the Dry Comfort feature is in use and the indoor temperature and humidity is high, the airflow blade opens to adjust the temperature and humidity. The airflow blade automatically closes when the temperature and humidity becomes comfortable level.

#### Change of the airflow blade by temperature and humidity

Indoor temperature and humidity	If temperature and humidity is low	If temperature and humidity is high
	<ul style="list-style-type: none"> <li>• Air blows from the WindFree panel</li> </ul>	<ul style="list-style-type: none"> <li>• Air blows from the airflow blade</li> </ul>
Airflow blade	Closed	Open

# Power Smart Features

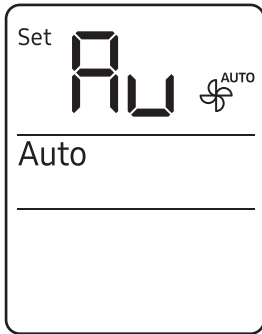



## AI Auto mode

Use AI Auto mode to automatically operate any of Cool, Dry, and WindFree Cooling modes depending on the learned user patterns gathered from an external server via Wi-Fi module. The favourite temperature and operation mode are also set based on the current temperatures (indoor/outdoor) and the gathered user patterns.

 ►  ► **Select Auto.**

### NOTE

- You can use this mode after Wi-Fi is connected. Otherwise, Auto mode is activated.
- In AI Auto mode, the  (AI Auto) and  (Wi-Fi) indicators appears on the display of the indoor unit.
- If the gathered user patterns are not sufficient, the set temperature is set based on the user's activity time and indoor/outdoor temperatures.
- The set temperature is controlled within the range of 22 °C to 28 °C in AI Auto mode. You can also change it manually.
- An automatically changed set temperature is shown on the display of the indoor unit.
- When you press  (Mode) in AI Auto mode, the mode is cancelled.
- If you change the set temperature in AI Auto mode, the air conditioner operates with the changed set temperature.

## AI Energy mode

- Use AI Energy mode to save electricity consumed by the operating air conditioner. This mode can be turned on or off from the SmartThings app only.
- The amount of saved electricity is calculated while in AI Auto mode only.
- AI Energy indicator  lights up on the display of the indoor unit.
- The amount of saved electricity is calculated from the moment when the air conditioner is turned on.
- The amount of saved electricity may differ even when using the same device, depending on the ambient environment (e.g., indoor/outdoor temperature and humidity), set temperature, and operation mode.
- Note that the amount of saved electricity also may differ even under the same operating environment conditions, depending on how it was measured.
- To have powerful cooling, turn off AI Energy mode in the SmartThings app.

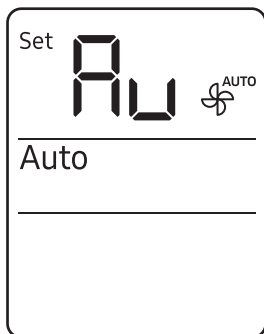

## Auto mode

Use Auto mode to perform the powerful cooling function to automatically reach the desired temperature. When the difference between the room temperature and the set temperature decreases, the air conditioner controls the fan speed and airflow direction.



### NOTE

- If Wi-Fi cannot be connected or the Wi-Fi function is not supported, this Auto mode is automatically activated instead of AI Auto mode.
- When the room temperature is higher than the set temperature, the air conditioner automatically produces cool air.

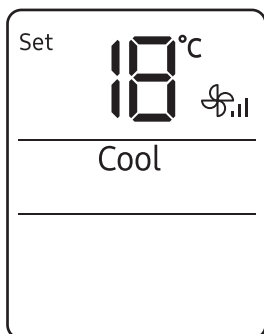

## Cool mode

Use Cool mode to stay cool in hot weather.



### NOTE

- After selecting Cool mode, select the desired function, temperature, and fan speed.
  - To cool more quickly, select a lower temperature and a faster fan speed.
  - To save energy, select a higher temperature and a slower fan speed.
  - As the room temperature nears the set temperature, the compressor motor will slow down to save energy.

# Power Smart Features

---

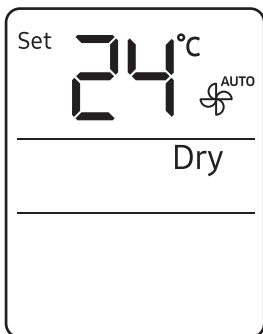

## Dry mode

---

Use Dry mode in rainy or humid weather.



### NOTE

- The proper set temperature range for dehumidifying operation is 24 to 26 °C. If you feel that the current humidity seems high, use a lower set temperature.

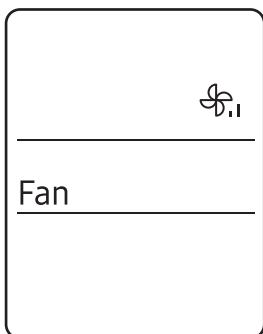

## Fan mode

---

Use Fan mode to run the air conditioner like a floor fan, providing a breeze without cooling.



### NOTE

- If the air conditioner will not be used for an extended period of time, run it in Fan mode for 3 to 4 hours to dry the internal components.
- The outdoor unit does not operate in Fan mode. This is normal and not a fault with the air conditioner.

# Variety Smart Features

---

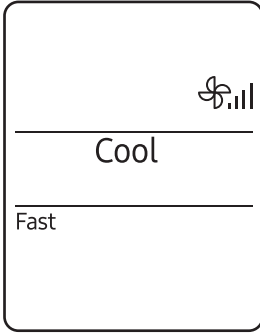

## Fast function

---

Use the Fast function to quickly cool your room. This function is the most powerful cooling function provided by the air conditioner. You can select this function in Cool mode.

In Cool mode ►  ► Press and hold for 3 or more seconds.

### NOTE

- You can change the airflow direction, but you cannot change the set temperature and the fan speed.
- Selecting the Fast function cancels the WindFree Cooling, Dry Comfort, 5 Step Cooling, Good Sleep, and Quiet functions.
- You can also start the Fast function from the Options menu:

In Cool mode ►  ►   ►

Select Fast. ► 

# Variety Smart Features

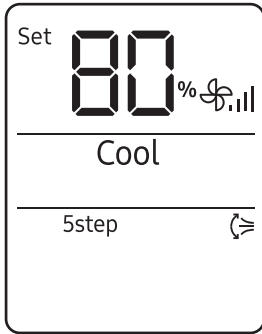

## 5 Step Cooling function

Use the 5 Step Cooling function to adjust the cooling speed by changing the operation rate of the outdoor unit.

In Cool mode ▶

### NOTE

- Each time you press the button in Cool mode, you can adjust the operation rate of the outdoor unit in 5 steps.
  - It switches in the following order: 80% → 60% → 40% → 120% → Cool mode.
  - The remote control display shows:

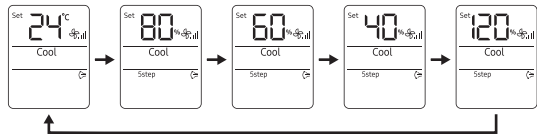

- When it is switched to Cool mode, the air conditioner starts running for the preset temperature.
- In the entry to the 5 Step Cooling function, the outdoor unit operates at 80% of operation rate and the vertical air swing of the indoor unit starts.
- You can adjust the desired temperature, fan speed, and airflow direction.
- When the operation rate of the outdoor unit is set to any of 80%, 60%, and 40%, you can save energy in cooling.
- When there are many people at the room in hot weather, select 120% of operation rate for strong cooling.
- When using the 5 Step Cooling function, the operating rate displayed on the remote controller and the actual power consumption ratio of the product maybe different depending on the indoor/outdoor temperature environment.

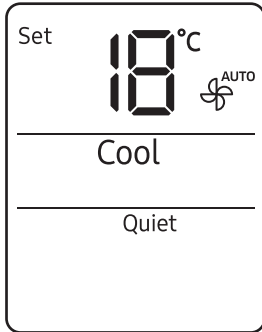

## Quiet function

Use the Quiet function to reduce the unit's operating noise. You can select this function in Cool mode.

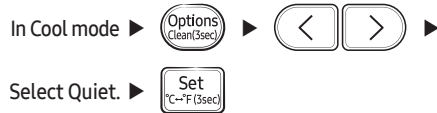

### NOTE

- You can change the set temperature and the airflow direction, but you cannot change the fan speed.
- Selecting the Quiet function cancels the WindFree Cooling, Dry Comfort, 5 Step Cooling, Good Sleep, and Fast functions.

# Variety Smart Features

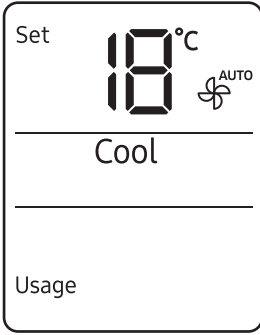

## Electricity consumption check

Use the Usage function to check the amount of electricity consumed by using the air conditioner. The amount consumed is displayed on the indoor unit display for a few seconds, and the set temperature appears.

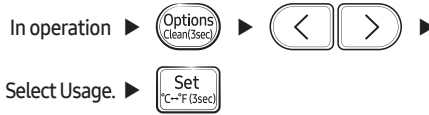

The value range displayed is between 0.1 kWh and 99 kWh. Electricity consumption is calculated from the moment the air conditioner turns on. The value is reset when the air conditioner turns off.

### NOTE

- The usage shown on the indoor unit display may slightly differ from the amount of electricity actually consumed.
- You can view electricity consumption only when the air conditioner is operating.

## Beep function

Use the Beep function to turn on or off the beep that sounds when you press a button on the remote control.

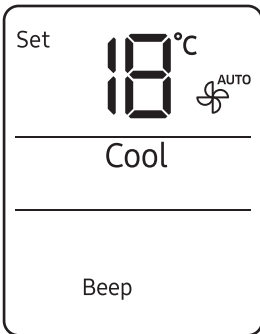

## Auto clean function

Use the Auto clean function if the indoor unit produces odors.

### Activating Auto clean

To activate Auto clean, press the  (Options) button for at least 3 seconds.

The indoor unit display shows:

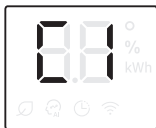

If the air conditioner is off, Auto clean starts immediately. If the air conditioner is running, Auto clean starts as soon as the air conditioner turns off.

#### NOTE

- You can also activate Auto clean from the Options menu:



- Once Auto clean is selected, it is always activated whenever the air conditioner turns off.
- Auto clean runs for 10 to up to 30 minutes depending on internal dry conditions. The indoor unit display shows the cleaning progress from 1% to 99%.
- If you start another function while Auto clean is progressing, Auto clean pauses and will resume when the other function stops.
- When Auto clean completes, the air conditioner turns off.
- Auto clean does run after Timed off and Good Sleep function operation, but Auto clean does not run after Fan mode.

# Variety Smart Features

## Canceling Auto clean

To cancel Auto clean while it is running, follow the procedure below:

 ► Press and hold for 3 or more seconds.

or

 ►   ► Select Clean. ► 

### NOTE

- Canceling Auto clean does not deactivate it.

## Deactivating Auto clean

To deactivate Auto clean, follow the procedure below while the air conditioner is in operation:

 ► Press and hold for 3 or more seconds.

or

 ►   ► Select Clean. ► 

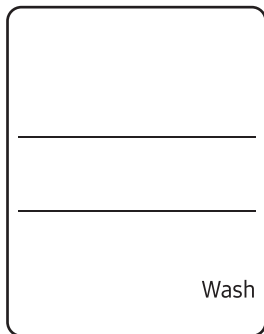

## Freeze Wash function

Use the Freeze Wash function to wash away microorganisms or dust on the surface of the indoor heat exchanger by freezing and thawing operation.

In operation stop condition,



### NOTE

- The Freeze Wash function runs from 30 to 80 minutes (running the outdoor unit) depending on either temperature or humidity in the room, through the following cycle:freezing → defrosting → drying of the indoor unit heat exchanger.
- The indoor unit display shows the cleaning progress (1-99 %).
- To use another function while in Wash operation, press the  (Power) button on the remote control to stop operation.
- When the room temperature is low or its humidity is high, the Freeze Wash function may not work.
- Before finishing the Freeze Wash function, the airflow blade is closed and then the drying operation starts.
- During the Freeze Wash cycle, when you hear a creaking noise from the indoor unit: DON'T worry because it is normal and it can happen! it will disappear at the end of the cycle.
- The area around the indoor unit may appear blurred or condensation may form while the Freeze Wash function is in operation.
- You may see frost or water on the surface of the outdoor unit's valve while the Freeze Wash function is in operation.
- It is recommended to use the Wash function once every 2 weeks. Otherwise, dust or dirt that is difficult to be removed may accumulate in the heat exchanger.

# Variety Smart Features

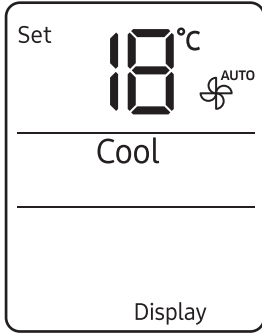

## Display lighting function

Use the Display lighting function to turn on or off the lighting of the indoor unit display.



### NOTE

- If you change the current mode or function when the Display lighting function is on, the display lighting turns on for 5 seconds and then turns off again.
- To turn off the Display lighting function, run the method above again or turn the product off and on.

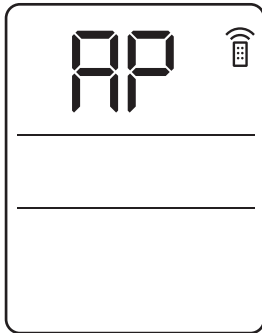



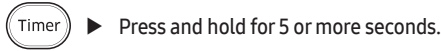

## Wi-Fi function (SmartThings app)

Turn on the Wi-Fi function to pair your smartphone with the air conditioner.



### NOTE

- When you turn on the Wi-Fi function, your smartphone pairs with the air conditioner, the  (Transmit) indicator blinks, and **AP** appears on the remote control display for a few seconds.
- Once your smartphone is connected with the air conditioner, you can control it via the wireless Internet using the SmartThings app installed on your smartphone.
- For more information about how to prepare your smartphone for connection and how to control the air conditioner using the SmartThings app, see "SmartThings app" on page 38.
- To turn on or off the Wi-Fi, press and hold  (Mode) and  for 5 seconds.
  - In order to launch the SmartThings app, press and hold the  (Timer) button for 5 seconds, which enables to connect the air conditioner.

# Time Scheduling

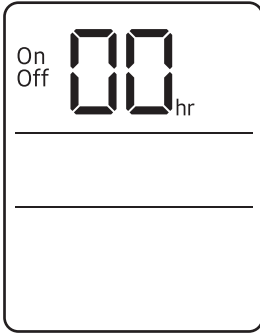

## Timed on/ Timed off function



Use the Timed on/off function to turn the air conditioner on or off after a duration. Scheduling durations before the air conditioner turns on or off helps use the air conditioner economically.



### NOTE

- To cancel the Timed on/off function, set the duration to 0.0.
- When you start the Timed on/off function, the  (Timer) indicator appears on the indoor unit display.
- You can set the duration to from 0.5 hours to 24 hours.
- You cannot set the same duration for both Timed on and Timed off functions.

### Combining Timed on and Timed off

Combining Timed on and Timed off	
<b>When the air conditioner is off</b>	<p>Example: Timed on 3 hours, Timed off 5 hours</p> <p>The air conditioner turns on 3 hours after the last time you press the  (SET) button to start the Timed on/off function, remains on for 2 hours, then turns off again.</p>
<b>When the air conditioner is on</b>	<p>Example: Timed on 3 hours, Timed off 1 hour</p> <p>The air conditioner turns off 1 hour after the last time you press the  (SET) button to start the Timed on/off function, remains off for 2 hours, then turns on again.</p>

# Time Scheduling

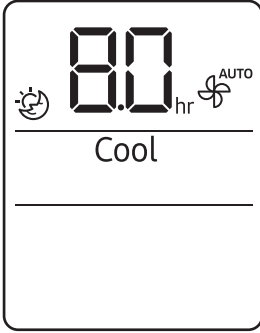

## Good Sleep function

Use the Good Sleep function to save energy while you are sleeping. You can select this function in Cool mode.



### NOTE

- To cancel the Good Sleep function, set the duration to 0.0.
- When you start the Good Sleep function, the  (Timer) indicator appears on the indoor unit display.
- You can set the duration to from 0.5 hours to 12 hours.
- The recommended set temperatures while the Good Sleep function is on are:

Mode	Recommended set temperature	Optimal set temperature
Cool	25 °C to 27 °C	26 °C

- The Good Sleep function can operate while the WindFree Cooling function is on.
- Selecting the Good Sleep function cancels Dry Comfort, 5 Step Cooling, Fast, and Quiet functions.

# Schedule

Task	How often	By whom	Instruction
Run the Auto clean function.	As needed	Owner	"Auto clean function" on page 25.
Run the Freeze Wash function.	Once every two weeks	Owner	"Freeze Wash function" on page 27.
Clean the filter.	Once every two weeks	Owner	"Cleaning the filter" on page 33.
Clean the WindFree panel	At least once a month	Owner	"Cleaning the WindFree panel" on page 34.
Clean the exterior of the indoor unit.	As needed	Owner	"Cleaning the outside of the indoor unit" on page 32.
Clean the exterior of the outdoor unit.	At least once a year	Owner	"Cleaning the heat exchanger on the outdoor unit" on page 32.
Replace the remote control batteries	As needed	Owner	"Replacing the remote control batteries" on page 13.
Apply corrosion inhibitor on outdoor unit. (Only if installed near salt water such as an ocean)	At least once a year	Qualified technician	Contact your service provider.
Clean inside the indoor or outdoor unit.	Once a year	Qualified technician	Contact your service provider.
Inspect the units, electrical connections, refrigerant pipes, and protections.	Once a year	Qualified technician	Contact your service provider.

# Cleaning

When cleaning or maintaining the product, wear clean gloves to prevent product damage and injury.

## Cleaning the outside of the indoor unit

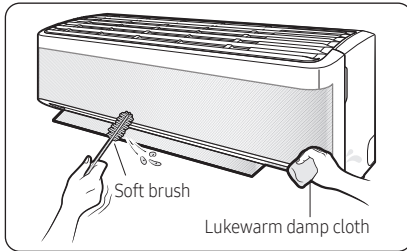

- 1 Turn off the air conditioner and wait until the fan stops.
- 2 Disconnect the power supply.
- 3 Use a soft brush or lukewarm damp cloth to clean the exterior.

### **WARNING**

- Do not clean the appliance by spraying water directly onto it. Water entering the unit may result in electric shock or fire that could cause death, serious injury, or property damage:

### **CAUTION**

- Do not use an alkaline detergent to clean the indoor unit display.
- Do not use sulphuric acid, hydrochloric acid, or organic solvents such as paint thinner, kerosene, acetone, benzene, or alcohol to clean the unit surfaces.

## Cleaning the heat exchanger on the outdoor unit

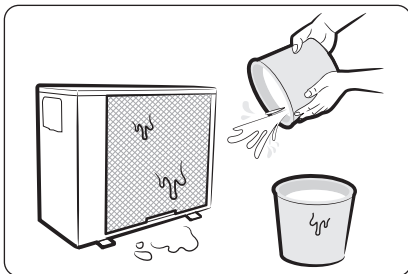

- 1 Turn off the air conditioner and wait until the fan stops.
- 2 Disconnect the power supply.
- 3 Spray water on the heat exchanger to remove dust and other debris.

### **CAUTION**

- Do not use sulphuric acid, hydrochloric acid, or organic solvents such as paint thinner, kerosene, acetone, benzene, or alcohol to clean the unit surfaces.
- If you need to inspect or clean the inside of the heat exchanger on the outdoor unit, contact a local service centre for help.

## Cleaning the filter

Clean the air filter every two weeks or when the **F** (filter-cleaning reminder) appears on the indoor unit display. The time between cleanings may vary, depending on the usage and environmental conditions.

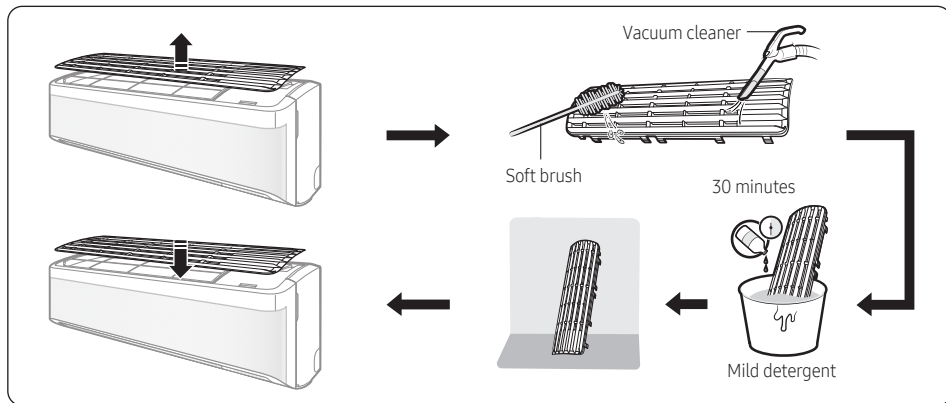

- 1 Slide the filter off of the unit.
- 2 Use a soft brush or vacuum cleaner to remove any dust or debris on the filter.
- 3 Soak the filter in a solution of water and mild detergent for 30 minutes.
- 4 Rinse the filter and let it air dry in a well-ventilated area that is out of direct sunlight.
- 5 Reinstall the filter.
- 6 Reset the filter-cleaning reminder:

In operation ▶ **Options** (Clean3sec) ▶ **<** **>** ▶ Select Filter Reset. ▶ **Set** (°C→°F (3sec))

### **!** CAUTION

- Take care not to damage the filter during cleaning.
- Do not scrub the air filter with a hard-bristle brush or another cleaning utensil.
- Do not expose the air filter to direct sunlight when drying it

# Cleaning

## Cleaning the WindFree panel

Clean the WindFree panel at least once a month.

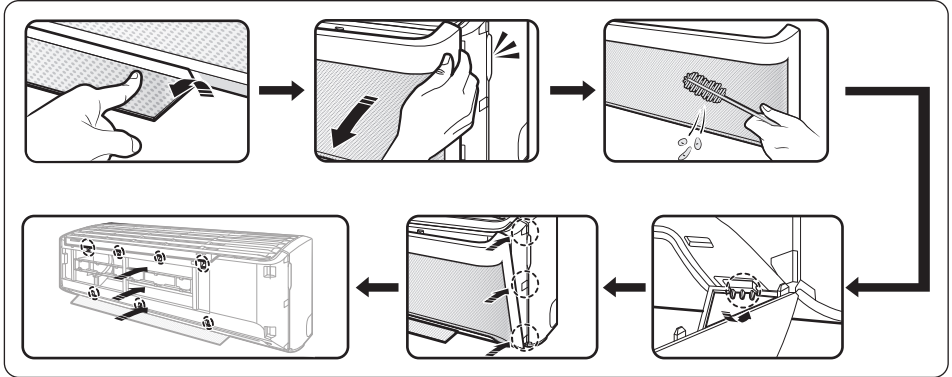

- 1 Pull the airflow blade open.
- 2 Hold and pull both sides of the WindFree panel until it comes free from the air conditioner.
- 3 Use a soft brush or vacuum cleaner to remove any dust.
- 4 Hang the WindFree panel in the grooves at the bottom left and right.
- 5 Align the projections of the WindFree panel with the grooves at the top, middle, and bottom of the front panel.
- 6 After inserting the WindFree panel, press the top 4 places and the bottom 3 places by hand so that there is no gap to the panel.

### CAUTION



- If you attach the WindFree panel without the airflow blade being open, it may become obstructed by the WindFree panel and may not open properly.

# Troubleshooting

If the air conditioner is not operating normally, refer to the troubleshooting guide below.

Problem	Solution
The air conditioner stops working.	<ul style="list-style-type: none"> <li>• Make sure the unit is receiving power.</li> <li>• Check the circuit breaker. If it is flipped off, flip it on again and restart the unit. If the problem persists, contact your service provider.</li> <li>• The Timed off function may have turned off the unit. Turn on the unit again.</li> </ul>
Cannot change the temperature.	<ul style="list-style-type: none"> <li>• Check if the unit is in Fan or Fast mode. If so, you cannot change the set temperature; the unit automatically controls the set temperature.</li> </ul>
Improper airflow temperature.	<ul style="list-style-type: none"> <li>• Check the set temperature. In Cool mode, cooling occurs only when the set temperature is lower than the current temperature.</li> <li>• Use the  (Temperature) button on the remote control to change the set temperature.</li> <li>• Check if the air filter is blocked with dirt or debris. If the air filter is blocked, the cooling performance may decrease. Clean the air filter regularly (page 33).</li> <li>• Check if the outdoor unit is covered or is installed near obstacles. Remove the coverings and obstacles.</li> <li>• Check if doors or windows are open. This may cause poor circulation or performance. Close all doors and windows.</li> <li>• Check if the pipe length between the units exceeds the maximum pipe length (see "Typical installation" in the Installation manual). If so, the cooling performance may decrease.</li> </ul>
Cannot change the airflow direction.	<ul style="list-style-type: none"> <li>• Check if the Good Sleep function is on in Cool mode. If so, you cannot control the airflow direction.</li> </ul>
Cannot change the fan speed.	<ul style="list-style-type: none"> <li>• Check if the unit is in Auto, Dry, or Fast mode or the Good Sleep function is on in Cool mode. In these conditions, you cannot control the fan speed; the unit automatically controls the fan speed.</li> </ul>

# Troubleshooting

Problem	Solution
The remote control does not work.	<ul style="list-style-type: none"> <li>• Replace the batteries in the remote control.</li> <li>• Make sure the remote control can send an unobstructed signal to the unit.</li> <li>• Keep bright lights away from the unit. Light from fluorescent bulbs or neon signs may interrupt the signal from the remote control.</li> </ul>
The Timed on/off function does not work.	<ul style="list-style-type: none"> <li>• Make sure to press the  (SET) button on the remote control when setting the timer.</li> </ul>
The indicator on the indoor unit display blinks continuously.	<ul style="list-style-type: none"> <li>• Press the  (Power) button to turn off the unit, or disconnect the power plug.</li> <li>• If the indicator light on the indoor unit display continues blinking, contact your service provider.</li> </ul>
Odors are coming from the unit during regular operation.	<ul style="list-style-type: none"> <li>• If the unit is operating in a smoky area, ventilate the room or operate the unit in Fan mode for 3 to 4 hours. There are no components in the unit that produce a strong odor.</li> <li>• Check if the drain pipes are clean. Clean them regularly.</li> </ul>
The indoor unit display shows an error message.	<ul style="list-style-type: none"> <li>• If the indoor unit indicator blinks, write down the error code. Contact your service provider and provide them with the error code.</li> </ul>
The unit is generating noise.	<ul style="list-style-type: none"> <li>• It is normal for the unit to generate some noise while operating. If the pipe length between the units is less than 3 m and no coil was used (see "Typical installation" in the Installation manual), additional noise may be transmitted from the outdoor unit to the indoor unit via the piping.</li> </ul>

Problem	Solution
Water drips from the pipe connections on the outdoor unit.	<ul style="list-style-type: none"> <li>• Condensation may develop when the ambient temperature or humidity changes significantly. This is normal.</li> </ul>
Condensation forms on the surface of the indoor unit.	<ul style="list-style-type: none"> <li>• If the humidity is higher in the room in Cool mode, or the difference between the desired temperature and indoor temperature is great, condensation may form on the surface of the indoor unit.</li> </ul>
During the operation of the air conditioner, "L0" can be displayed in the indoor unit.	<ul style="list-style-type: none"> <li>• This situation occurs when the in-house input voltage is excessively high or low. (If it is out of AC 290V ~ 120V range, it may occur.) During the "L0" indicated, the outdoor unit is not operated and also the cooling operation is interrupted. When the indoor voltage enters the outdoor unit operation range again, the "L0" mark is turned off, and the outdoor unit is operated after 3 minutes. If "L0" occurs frequently while using the air conditioner, check whether there is any problem in the power supply system of your house.</li> </ul>

# SmartThings app

---

Use the SmartThings app on your smartphone to control the air conditioner via the wireless Internet.

To remotely control the air conditioner, you need to connect your smartphone to the air conditioner. If already connected, skip to "Step 6. Controlling the air conditioner with your smartphone" on page 39.

## Step 1. Checking the requirements for connection

Before connecting your smartphone with the air conditioner, make sure that the following requirements are met:

- Wi-Fi access point: 2.4 GHz Wi-Fi access point only
- The air conditioner and your smartphone must be within the coverage of the same Wi-Fi access point and connected to it. After the connection, you can control the air conditioner from any place via various wireless networks such as Wi-Fi, 3G, LTE and 5G.
- The supporting software version of the SmartThings app is subject to change according to the OS supporting policy the manufacturer provides. In addition, as for the SmartThings app or the functions that the app supports, the new application update policy on the existing OS version can be suspended due to usability or security reasons.
- The SmartThings app is subject to change without notice to improve usability or performance. As the mobile phone OS version is updated every year, the SmartThings is also updated continually according to the latest OS.
- If you have enquiries regarding the items mentioned above, please contact us on [st.service@samsung.com](mailto:st.service@samsung.com).

## Step 2. Connecting your smartphone to the Wi-Fi network

- 1 Turn on the Wi-Fi access point.
- 2 Tap **Settings** → **Wi-Fi** on your smartphone.
- 3 Tap the **Wi-Fi** switch to activate it, and then select the 2.4 GHz Wi-Fi access point to connect to.
- 4 If needed, enter the password for the access point.
- 5 Tap **Advanced**.
- 6 Tap the **Switch to mobile data** switch to deactivate it.

## Step 3. Installing the SmartThings app

If the SmartThings app is not installed on your smartphone, follow the procedure below. If installed, skip to "Step 4. Configuring the SmartThings app" on page 38.

- 1 Launch **Play Store** or **App Store**.
- 2 Tap the search field, and then search for "SmartThings".
- 3 Tap **INSTALL** for the found SmartThings app item.
- 4 Select **Agree**.



## Step 4. Configuring the SmartThings app

After the SmartThings app is installed, follow the procedure below to configure it. If already configured, skip to "Step 5. Connecting your smartphone to the air conditioner" on page 39.

- 1 Launch the **SmartThings** app.
- 2 When you see pop-up windows asking for location, Wi-Fi, Bluetooth permissions, tap **Start**.
- 3 Tap **Sign In**.
- 4 Sign in to your **Samsung account**.
  - If you have no Samsung account, create your Samsung account.
- 5 Consent to **TERMS AND CONDITIONS**.
- 6 When you see a pop-up window asking for access permission to location information, tap **ALLOW**.

## Step 5. Connecting your smartphone to the air conditioner

- 1 Plug in the power cord of the air conditioner, and then turn on the power.
- 2 Launch the **SmartThings** app.
- 3 Tap **Add device** on the home screen of the SmartThings app.
- 4 Tap **Samsung Air conditioner** > **Room air conditioner**.
- 5 Press the **Timer** (Timer) button on the remote control for at least 4 seconds.

To notify that registration of the selected air conditioner to your Samsung account is in progress, the  (Transmit) indicator blinks for several seconds and **RF** appears on the remote control display. When the connection is finished, the  (Transmit) indicator turns off and **RF** disappears. A new device card for the selected air conditioner is added to the home screen of the SmartThings app.

## Step 6. Controlling the air conditioner with your smartphone

- 1 Launch the SmartThings app.
- 2 On the home screen of the SmartThings app, tap the device card for the air conditioner, which was added when you proceeded with "Step 5. Connecting your smartphone to the air conditioner" on page 39.



### WARNING

- RF exposure warning statement – for keeping 20cm distance when installing this module.
- Warning that this module should not be installed and operating simultaneously with other radio without additional evaluation or FCC filing.
- Instruction for host system labeling, the host system should have proper label showing that it "Contains FCC ID : A3LSWL-B70F"
- Your device uses non-harmonised frequency and is intended for use in all European countries. The WLAN can be operated in the EU without restriction indoors, but cannot be operated outdoors in France.

## Specifications

Wi-Fi	
Frequency Range	Transmitter Power (Max)
2412 - 2472 MHz	20 dBm

## Open Source Announcement

The software included in this product contains open source software. You may obtain the complete corresponding source code for a period of three years after the last shipment of this product by contacting our support team via <http://opensource.samsung.com> (Please use the "Inquiry" menu.)

It is also possible to obtain the complete corresponding source code in a physical medium such as a CD-ROM; a minimal charge will be required.

The following URL [http://opensource.samsung.com/opensource/SMART\\_AT\\_051/seq/0](http://opensource.samsung.com/opensource/SMART_AT_051/seq/0) leads to the open source license information as related to this product. This offer is valid to anyone in receipt of this information.



## Security updates information

Security updates are provided to strengthen the security of your device and protect your personal information. For more information on security updates, visit <https://security.samsungda.com>.

\* The website supports only some languages.

QUESTIONS OR COMMENTS?

COUNTRY	CALL	OR VISIT US ONLINE AT
INDIA	1800 40 7267864 (1800 40 SAMSUNG) 1800 5 7267864 (1800 5 SAMSUNG)	<a href="http://www.samsung.com/in/support">www.samsung.com/in/support</a>

This product is RoHS compliant